

Device Consulting

ПОСТАВКА ЭЛЕКТРОННЫХ КОМПОНЕНТОВ

Официальный дистрибьютор **Shihlin Electric**

ООО "ДевайсКонсалтинг"

Россия, Санкт-Петербург, ул. Аэродромнаяд. 6, ЛИТА, офис 45

8 (800) 777 - 18 - 79

<https://device.consulting>



Device Consulting
ПОСТАВКА ЭЛЕКТРОННЫХ КОМПОНЕНТОВ

AC Drive Family

Superior Performance for all Industries



www.shihlin.ru

About US

Shihlin Electric Group was established in 1955 with headquarter located in Taipei, Taiwan. The company has offered a wide range of services that cover the areas of power distribution system, automobile equipment, low-voltage electrics, factory automation, and system engineering. The products of Shihlin Electric, including universal circuit breaker, molded case circuit breaker, mini circuit breaker, contactor, thermal overload relay, surge protection device, automatic transfer switch, power transformer, switch cabinet, high-voltage switch, capacitor, programmable controller, ac drives, human-machine interface, servo motors & drives, temperature controller, sensor, car alternator, starter motor, etc., are famous for their excellence in quality, which are well appreciated by the clients in the industries.



SA3 Series

01



SE3 Series

13

SC3 Series

23

SS2 Series

31

SE2 Series

39

SF-G Series

47

Optional Equipment

55

Braking Unit (BKU)

59

SA3 Series

Compact Design
Vector Control AC Drive

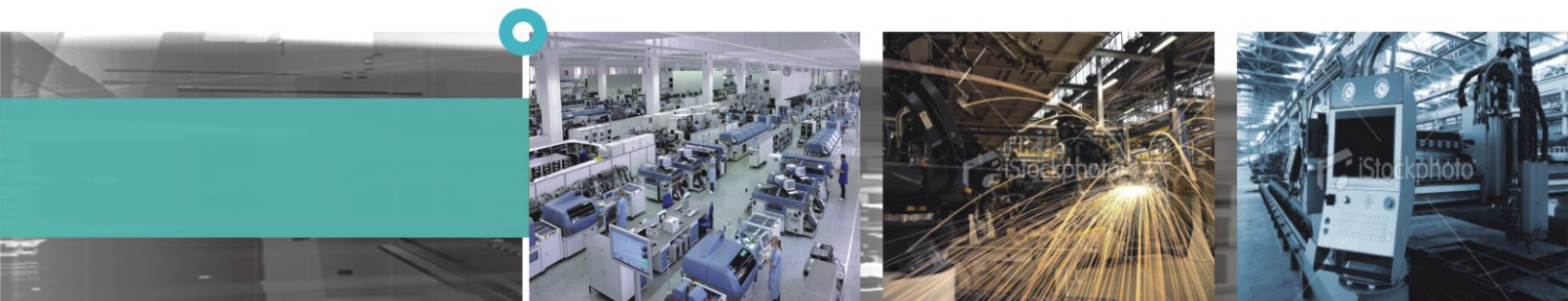

Product Range

Model	KW (HP)	0.75 (1)	1.5 (2)	2.2 (3)	3.7 (5)	5.5 (7.5)	7.5 (10)	11 (15)	15 (20)	18.5 (25)	22 (30)	30 (40)	37 (50)	45 (60)	55 (75)	75 (100)	90 (120)	110 (150)	132 (175)	160 (215)	185 (250)	220 (300)	250 (335)	280 (375)	315 (420)
SA3	023	3-Phase 220V																							
	043	3-Phase 440V																							

Product Features

High Performance Vector Control Technology

- Vector control and Sensorless vector control (Maximum operating frequency 120 Hz).
- High starting torque: Sensorless vector control (SVC) 150% 0.3Hz, and closed-loop vector control(FOC + PG) 180% 0Hz.

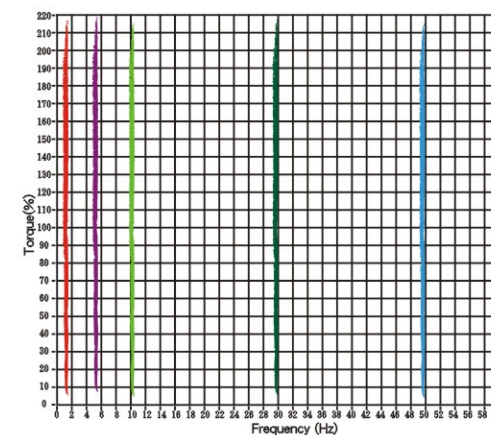

High Response Performance

- Speed accuracy: less than 1% with 0 to 100% load variation
- For applications with sudden load changes such as cranes and metal processing machinery.

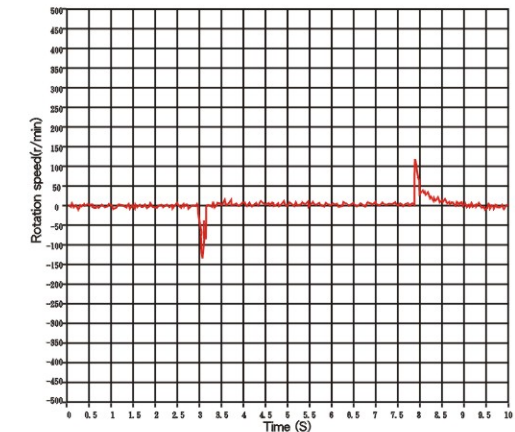

High Overload Capacity

- Significantly improved overload capacity to 150% for 60 seconds and 200% for 3 seconds, making it suitable for tooling machinery applications that requires the ability to handle sudden load changes.

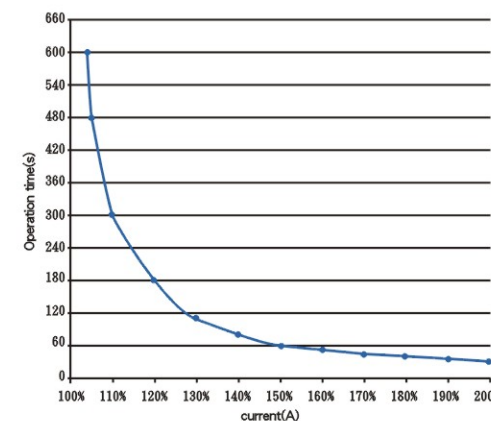

4-Quadrant Torque Control and Limits

- Parameters or analog signals can be used to simply establish limits for 4 torque items.

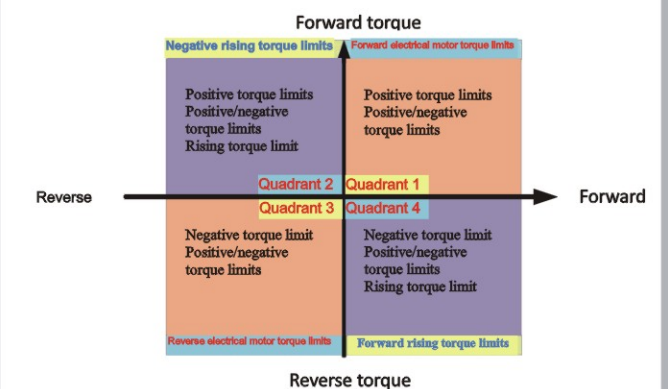

Product Features

Temporary Compensation at Low Voltage

- During temporary power disruptions, output frequency can be controlled in order to maintain the DC bus voltage of the AC drive to control motor deceleration or stoppage.
- When power is restored, the AC drive will carry out re-acceleration to attain the frequency prior to power stoppage.
- May be applied to equipment which is not permitted to operate when idle.

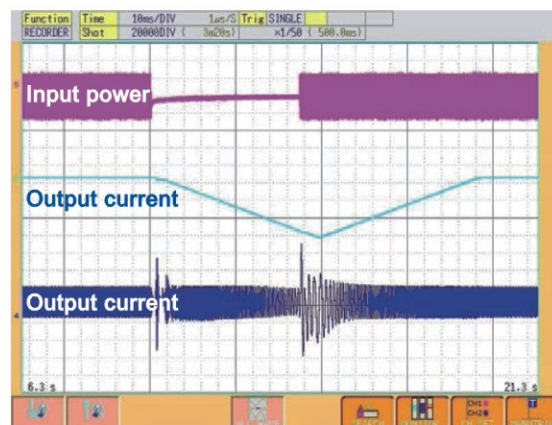

Magnetic Flux Brake

- When the motor is stopping, the magnetic flux will be transmitted to the motor coil to shorten deceleration time without relying on regenerative resistance.

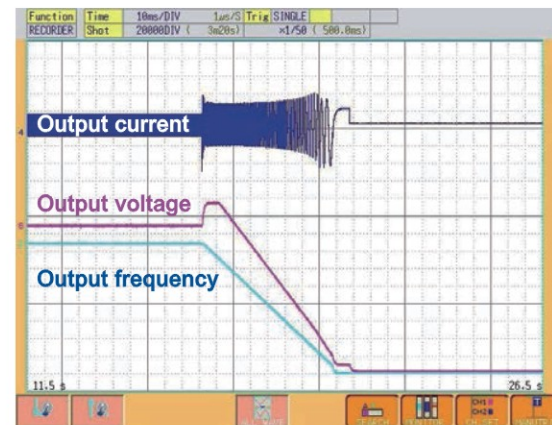

Regeneration Avoidance Functions

- By adjusting output frequency and voltage, DC bus voltage can be kept at a specified value and prevent overvoltage.

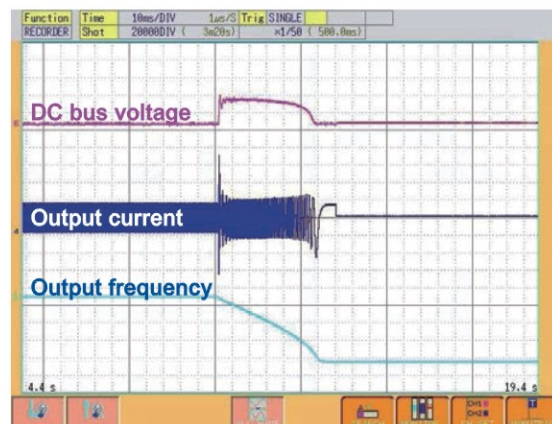

Low-noise Carrier Wave Control (Soft-PWM)

- Motor noise is controlled so that the metallic sound is transformed into a more pleasing buzz.
- Low noise operations to reduce the interference exerted upon external radio frequencies

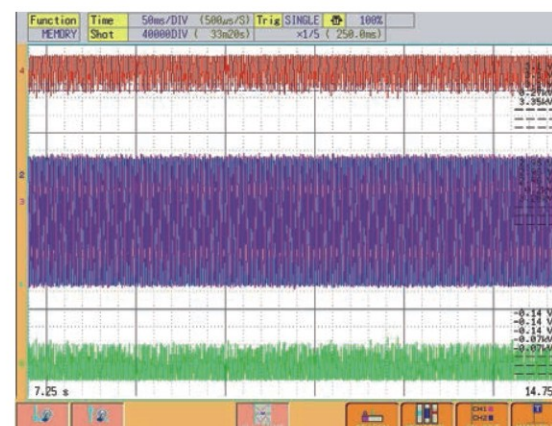

High Performance synchronous Motor Control Technology

- Supports induction motor (IM) and synchronous motor (IPM and SPM) control.
- Supports open loop synchronous motor control.



LCD Operation Interface

- Supports 2 display styles.
- Able to simultaneously display 6 sets of operational data.
- Calendar support.
- Offers both English and Chinese language interfaces.
- Capable of storing 3 sets of parameters.
- Supports shuttle settings.



Isolated Air Channel

- Fan wind channels are sealed and isolated from the heat dissipation system and electrical parts. Dust will not be able to infiltrate the interior of the machine through the fans.

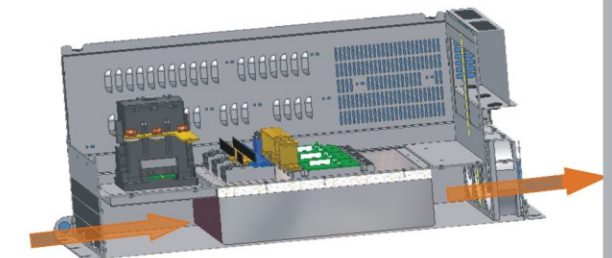

Supports Multiple Control Modes for Different Applications

- Built in position control, speed control, and tension control functions.
- Through I/O switching, multiple control functions can be applied to speed, torque, and position controls.
- Position control function supports home position return mode, zero servo control, and single-axis position control mode (Selective options: PG301C, PG301L, PG302L)
- Supports open-loop tension control, feeding disruption inspection, and automatic spool replacement functions.

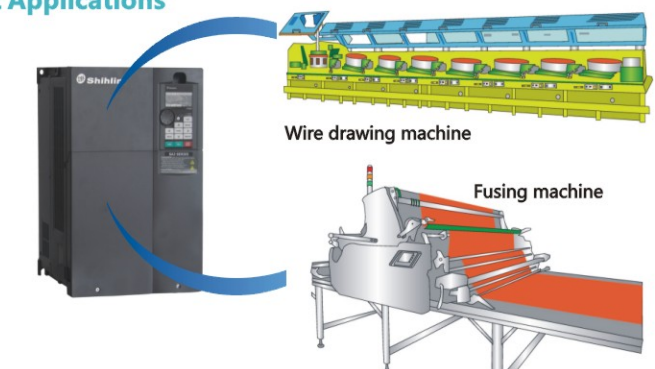

Product Features

Multiple I/O Terminals

- Includes 10 sets of multi-functional combinational logic input terminals (with high-speed pulse inputs *1)
- Includes 5 sets of multi-functional combinational output terminals (including electric relay output *2, transistor output *2, and high-speed pulse output *1).
- Includes 3 sets of analog input signals (with -10~+10V*1 and 4~20mA/0~10V*2).
- Includes 2 sets of analog output signals (0~20mA/0~10V*2).
- 1 set of safety switch (S1~SC).

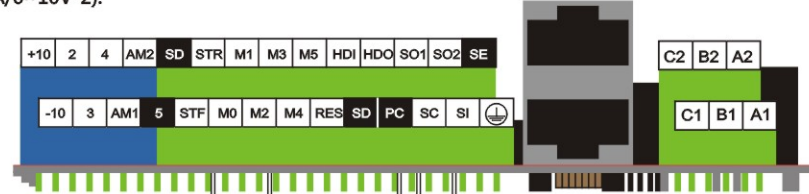

Built-in PLC Functions

- Provides PLC programming software, easy for editing.
- Applicable for programming small number of points, and support multiple functions.

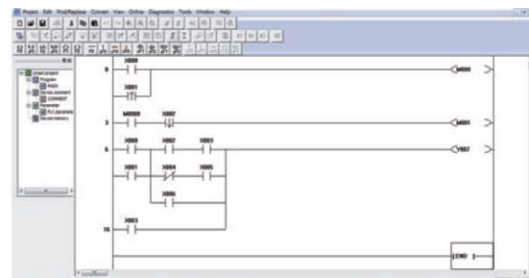

Item	SA3 PLC functions	
Programming Language	Ladder diagram + Command	
Basic commands	21	
Applicable commands	14	
Processing speed	Basic commands	1 μs
	Applicable commands	10 μs
Hidden program capacity	400 steps(0-399 steps)	
I/O configuration	Input(X)	22 points(X0~X25, octal)
	Output(Y)	20 points(Y0~Y23, octal)
Supporting electric relay (M)	General	160 points, M0~M159
	Battery backed	80 points, M160~M239
Timer(T)	Special	64 points, M8000~M8063
	General	8 points, T0~T7, timer range: 0~6553.5 seconds
Counter(C)	Special	8 points, C0~C7, counting range: 0~65535
	General	32 points, C0~C31
Data register	Battery backed	16 points, D52~D47
	Special	64 points, D8000~D8063

12 Sets of Alarm Records

- Complete alarm system for recording the output frequency, output current, output voltage, accumulated count of temperature increase, PN voltage, total AC drive operation time, AC drive operational status, alarm output time(only when used with PU301C)

Improved Protection

- Output phase failure protection, output short circuit protection, ground leakage protection, low voltage protection, motor overheating signal (PTC), and electrolytic capacitor life inspection.

Through-the-wall Installation Support Provided for the Entire Series

- Improve heat dissipation, reduce heat generation within the cabinet, and improve protection for the cabinet contents.

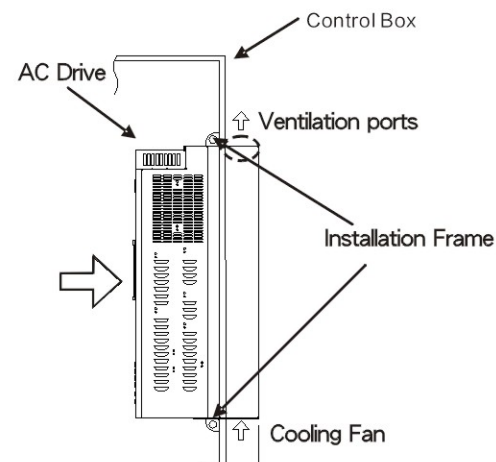

SA3 All-Series Built-in RFI Filter

- RFI is capable of suppressing electromagnetic interference

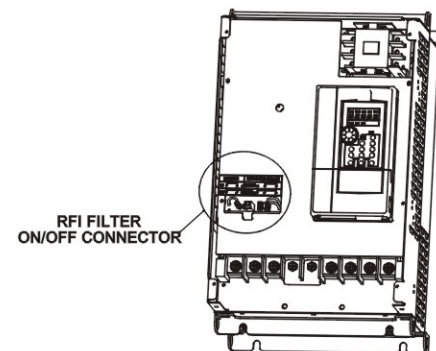

Applicable Industries



Air Compressor

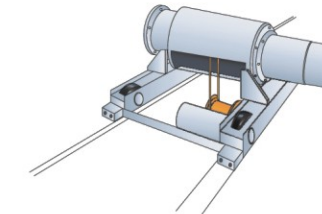

Cranes

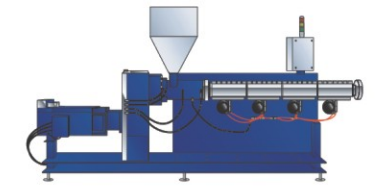

Extrusion Machine

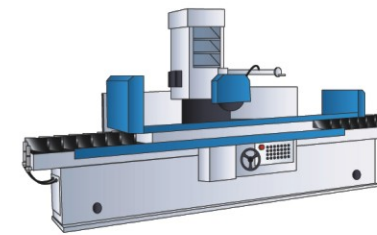

Grinding Machine

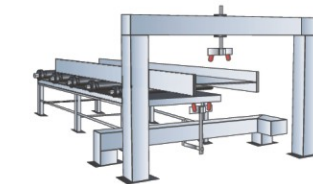

Printing press

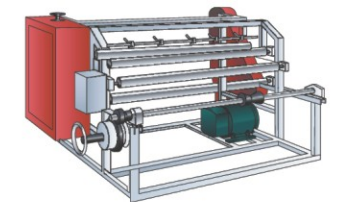

Textile Equipment

Electrical Specifications

220 V Three-phase Series

Frame	A	B	C	D	E	F	G											
Model SA3-023-□□□□□□	0.75K 1.5KF	1.5K 2.2KF	2.2K 3.7KF	3.7K 5.5KF	5.5K 7.5KF	7.5K 11KF	11K 15KF	15K 18.5KF	18.5K 22KF	22K 30KF	30K 37KF	37K 45KF	45K 55KF	55K 75KF	75K 90KF	90K 110KF	110K 132KF	
Output	Rated output capacity (kVA)	2	3.2	4.2	6.7	9.5	12.5	18.3	24.7	28.6	34.3	45.7	55	65	82	110	132	165
	Rated output current (A)	5	8	11	17.5	25	33	49	65	75	90	120	145	170	215	288	346	432
	Applicable motor capacity (HP)	1	2	3	5	7.5	10	15	20	25	30	40	50	60	75	100	120	145
	Applicable motor capacity (kW)	0.75	1.5	2.2	3.7	5.5	7.5	11	15	18.5	22	30	37	45	55	75	90	110
	Overload current rating	150% 60 seconds 200% 3seconds (inverse time characteristics)																
	Carrier frequency (kHz)	1~15kHz									1~9kHz							
Output	Rated output capacity (kVA)	3.2	4.2	6.7	9.5	12.5	18.3	24.7	28.6	34.3	45.7	55	65	82	110	132	165	193
	Rated output current (A)	8	11	17.5	25	33	49	65	75	90	120	145	170	215	288	346	432	506
	Applicable motor capacity (HP)	2	3	5	7.5	10	15	20	25	30	40	50	60	75	100	120	145	175
	Applicable motor capacity (kW)	1.5	2.2	3.7	5.5	7.5	11	15	18.5	22	30	37	45	55	75	90	110	132
	Overload current rating	120% 60seconds (inverse time characteristics)																
	Carrier frequency (kHz)	1~15kHz									1~9kHz							
Maximum output voltage	Three-phase 200-240V																	
Power supply	Rated power voltage	Three-phase 200-240V 50Hz / 60Hz																
	Power voltage permissible fluctuation	Three-phase 170-264V 50Hz / 60Hz																
	Power frequency permissible fluctuation	±5%																
	Power source capacity (kVA)	2.5	4.5	6.4	10	12	17	20	28	34	41	52	65	79	100	110	132	165
Cooling method	Self cooling / Forced air cooling																	
Weight (kg)	3.15	3.15	3.15	3.15	6	6	6	10.6	10.6	33	33	33	42.7	42.7	56.5	89.28	90.24	

Note: The test conditions of rated output current, rated output capacity and frequency converter inverter power consumption are: the carrier frequency (P72) is at the set value; the frequency converter/inverter output voltage is at 220V; the output frequency is at 60Hz, and the ambient temperature is 40°C.

Electrical Specifications

440 V Three-phase Series														
Frame		A					B			C		D		
Model SA3-043-□□□□□□-		0.75K 1.5KF	1.5K 2.2KF	2.2K 3.7KF	3.7K 5.5KF	5.5K 7.5KF	7.5K 11KF	11K 15KF	15K 18.5KF	18.5K 22KF	22K 30KF	30K 37KF	37K 45KF	
Output	HD	Rated output capacity (kVA)	2	3	4.6	6.9	10	14	18	25	29	34	46	56
		Rated output current (A)	3.0	4.2	6	9	12	17	24	32	38	45	60	73
		Applicable motor capacity (HP)	1	2	3	5	7.5	10	15	20	25	30	40	50
		Applicable motor capacity (kW)	0.75	1.5	2.2	3.7	5.5	7.5	11	15	18.5	22	30	37
		Overload current rating	150% 60 seconds 200% 3seconds (inverse time characteristics)											
	ND	Carrier frequency (kHz)	1 ~ 15kHz											1 ~ 9kHz
		Rated output capacity (kVA)	3	4.6	6.9	10	14	18	25	29	34	46	56	69
		Rated output current (A)	4.2	6	9	12	17	24	32	38	45	60	73	91
		Applicable motor capacity (HP)	2	3	5	7.5	10	15	20	25	30	40	50	60
		Applicable motor capacity (kW)	1.5	2.2	3.7	5.5	7.5	11	15	18.5	22	30	37	45
Overload current rating	120% 60seconds (inverse time characteristics)													
Carrier frequency (kHz)	1 ~ 15kHz											1 ~ 9kHz		
Maximum output voltage	Three-phase 380-480V													
Power supply	Rated power voltage	Three-phase 380-480V 50Hz / 60Hz												
	Power voltage permissible fluctuation	Three-phase 342-528V 50Hz / 60Hz												
	Power frequency permissible fluctuation	±5%												
	Power source capacity (kVA)	2.5	4.5	6.9	10.4	11.5	16	20	27	32	41	52	65	
	Cooling method	Self cooling	Forced air cooling											
Weight (kg)	3.15	3.15	3.15	3.15	3.15	6	6	6	9.8	9.8	9.8	33		

Frame		D			E		F		G			H		
Model SA3-043-□□□□□□-		45K 55KF	55K 75KF	75K 90KF	90K 110KF	110K 132KF	132K 160KF	160K 185KF	185K 220KF	220K 250KF	250K 280KF	280K 315KF	315K 355KF	
Output	HD	Rated output capacity (kVA)	69	84	114	137	168	198	236	295	367	402	438	491
		Rated output current (A)	91	110	150	180	220	260	310	340	425	480	530	620
		Applicable motor capacity (HP)	60	75	100	120	150	175	215	250	300	335	375	420
		Applicable motor capacity (kW)	45	55	75	90	110	132	160	185	220	250	280	315
		Overload current rating	150% 60 seconds 200% 3seconds (inverse time characteristics)											
	ND	Carrier frequency (kHz)	1~9kHz											1~6kHz
		Rated output capacity (kVA)	84	114	137	168	198	236	295	367	402	438	491	544
		Rated output current (A)	110	150	180	220	260	310	340	425	480	530	620	683
		Applicable motor capacity (HP)	75	100	120	150	175	215	250	300	335	375	420	475
		Applicable motor capacity (kW)	55	75	90	110	132	160	185	220	250	280	315	355
Overload current rating	120% 60seconds (inverse time characteristics)													
Carrier frequency (kHz)	1~9kHz											1~6kHz		
Maximum output voltage	Three-phase 380-480V													
Power supply	Rated power voltage	Three-phase 380-480V 50Hz / 60Hz												
	Power voltage permissible fluctuation	Three-phase 342-528V 50Hz / 60Hz												
	Power frequency permissible fluctuation	±5%												
	Power source capacity (kVA)	79	100	110	137	165	198	247	295	367	402	438	491	
	Cooling method	Powered fan-cooling												
Weight (kg)	33	33	33	42.7	42.7	56.5	84	84	84	84	123	123		

Note: The test conditions of rated output current, rated output capacity and frequency converter AC Drive power consumption are: the carrier frequency (P:72) is at the set value; the frequency converter/AC Drive output voltage is at 440V; the output frequency is at 60Hz, and the ambient temperature is 40°C.

Common Specifications

Control method	SVPWM control, V/F control, close-loop V/F control (VF+PG), general flux vector control, sensorless vector control (SVC), close-loop vector control (FOC+PG), torque control (TQC+PG).		
Output frequency range	0~650.00Hz		
Frequency setting resolution	Digit setting	The resolution is 0.01Hz.	
	Analog setting	0.01Hz/60Hz (Terminal 2: -10~+10V/13bit) 0.015Hz/60Hz (Terminal 2: 0~±10V/12bit; Terminal 3: 0~10V, 4-20mA/12bit) 0.03Hz/60Hz (Terminals 2, 3; 0~5V/11bit) 0.06Hz/60Hz (Terminal 4: 0~10V, 4-20mA/10bit) 0.12Hz/60Hz (Terminal 4: 0~5V/9bit)	
Output frequency accuracy	Digit setting	Maximum target frequency ±0.01%.	
	Analog setting	Maximum target frequency ±0.1%.	
Speed control range	IM: When SVC, 1:200; when FOC+PG, 1:1000. PM: When SVC, 1:20; when FOC+PG, 1:1000.		
Start torque	150% 0.3Hz (SVC), 180% 0Hz (FOC+PG).		
V/F characteristics	Constant torque curve, variable torque curve, five-point curve, VF separation		
Acceleration / deceleration curve characteristics	Linear acceleration /deceleration curve, S pattern acceleration /deceleration curve1 & 2 & 3		
Driving motor	Induction motor (IM), permanent magnet motor (SPM and IPM)		
Stall current protection	The stalling protection level can be set to 0~400% (06-01(P22)). The default value is 150%.		
Target frequency setting	Parameter unit setting, DC 0~5V/10V signal, DC -10~+10V signal, DC 4~20 mA signal, multiple speed stage level setting, communication setting, HDI setting.		
PID control	Please refer to 08-00~08-01, 08-04~08-14 / P.170~P.182 in chapter 4.		
Built-in simple PLC	Supports 21 basic instructions and 14 application instructions, including PC editing software;		
Operation panel	Operation monitoring	Output frequency, output current, output voltage, PN voltage, output torque, electronic thermal accumulation rate, temperature rising accumulation rate, output power, Analog value input signal, digital input and output terminal status...; alarm history 12 groups at most, the last group of alarm message is recorded.	
	LED indication lamp (I/O)	Forward rotation indication lamp, reverse rotation indication lamp, frequency monitoring indication lamp, voltage monitoring indication lamp, current monitoring indication lamp, NET indication lamp, PU control indication lamp, EXT indication lamp, PLC indication lamp and MON monitoring indication lamp.	
Communication functions	RS-485 communication, can select Shihlin/Modbus communication protocol, communication speed 38400bps or below, built-in CanOpen protocol (SA3-CP301 expanded board can be optional), double RJ-45 connectors (the connector can also be connected to parameter unit)		
Protection mechanism/ alarm function	Output short circuit protection, Over-current protection, over-voltage protection, under-voltage protection, motor over-heat protection (06-00(P:9)), IGBT module over-heat protection, communication abnormality protection, PTC temperature protection etc, electrolytic capacitor overheat, input and output phase failure, to-earth (ground) leakage currents protection, circuit error detection...		
Environment	Ambient temperature	Over load : -10 ~ +50°C (non-freezing) , Light load : -10 ~ +40°C (non-freezing), please refer to 3.4.5 Class of protection and operation temperature for details.	
	Ambient humidity	Below 90%Rh (non-condensing).	
	Storage temperature	-20 ~ +65°C	
	Surrounding environment	Indoors, no corrosive gases, no flammable gas, no flammable powder.	
	Altitude	Altitude below 3000 meters, when altitude is above 1,000 m, derate the rated current 2% per 100 m Note 1: according to the safety of CE certification to meet specification EN61800-5-1, this series of frequency converter, using at an altitude of less than 3000 m, can be installed under the environment that could satisfy the requirement of the overvoltage level II, while using at an altitude of less than 2000 m, can be installed in conditions that could satisfy the requirement of overvoltage level III worse environment.	
Vibrations	Vibration below 5.9m/s ² (0.6G).		
Grade of protection	Frame A, B, C, IP20 / NEMA TYPE 1, Frame D and above IP00 / UL OPEN TYPE (IP20 option can be selected).		
The degree of environmental pollution	2		
Class of protection	Class I		
International certification	CE		

Wiring Diagram

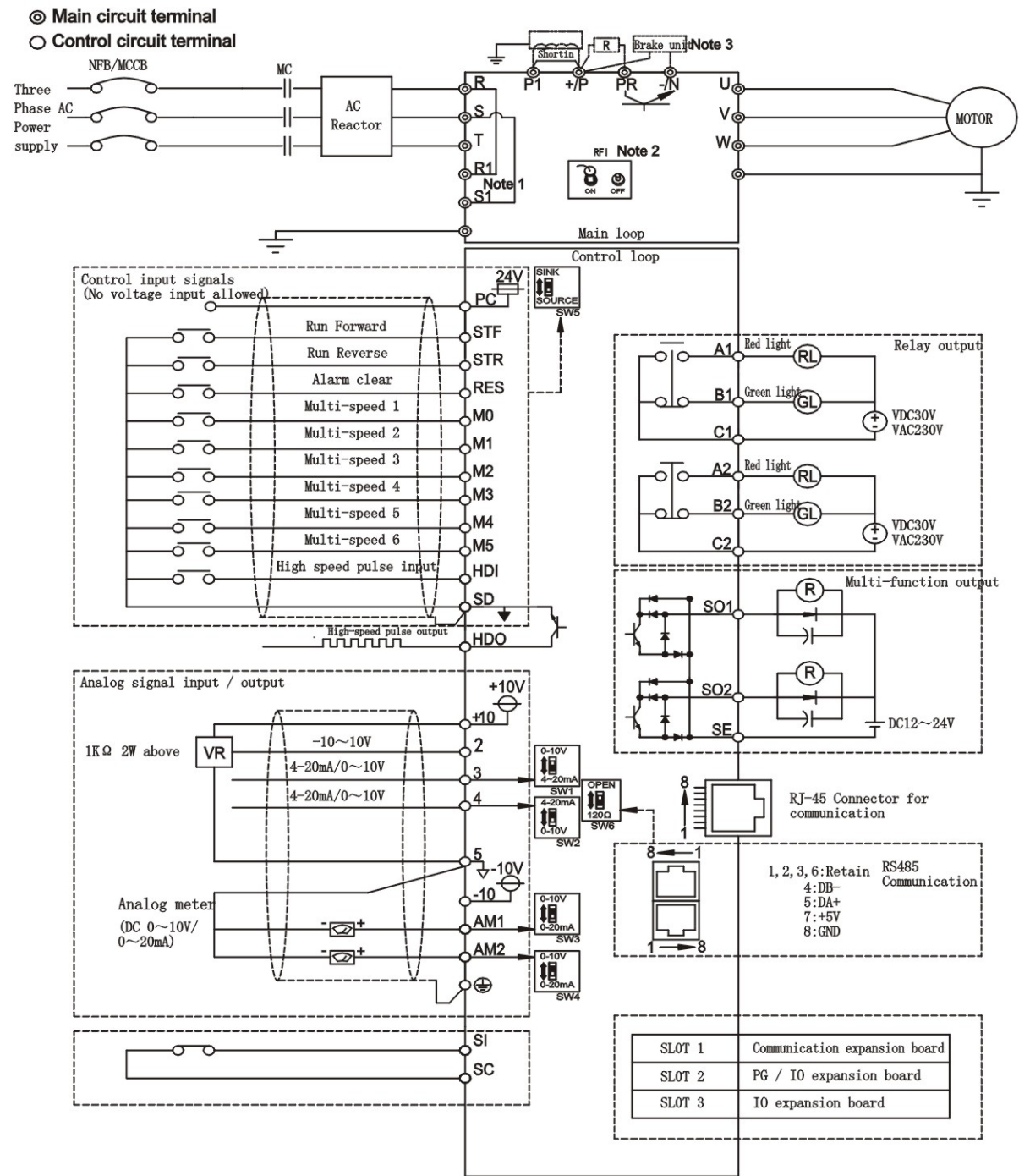

NOTE

- R1, S1 terminal is only D ~ H framework, specific wiring please refer to the section 3.7.5.
- RFI filter Settings, please refer to section 3.7.4.
- The brake resistor connection approach between +/P and PR is for Frame A, B and C only. For connecting the brake unit of Frame D, E, F, G and H to between +/P and -/N, please refer to the Section 3.7.1 for details.
- The DC resistor between +/P and P1 is optional. Please short +/P and P1 when AC resistor is not used.
- When adding DC reactors, please remove the short circuit piece between P1 and +/P. Please refer to the Section 3.6.4 for the reactor type.
- Please refer to the Section 5.3.9 for wiring of HDO.

Dimensions

Frame A

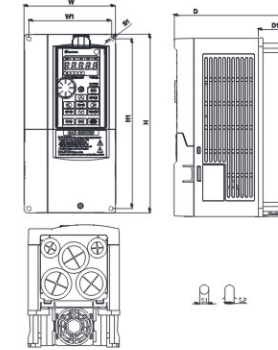

Frame A								
Model type	W (mm)	W1 (mm)	H (mm)	H1 (mm)	D (mm)	D1 (mm)	S1 (mm)	S2 (mm)
SA3-043-0.75K/1.5KF	130.0	116.0	250.0	236.0	170.0	51.3	6.2	6.2
SA3-043-1.5K/2.2KF								
SA3-043-2.2K/3.7KF								
SA3-043-3.7K/5.5KF								
SA3-043-5.5K/7.5KF								
SA3-023-0.75K/1.5KF								
SA3-023-1.5K/2.2KF								
SA3-023-2.2K/3.7KF								
SA3-023-3.7K/5.5KF								

Frame B

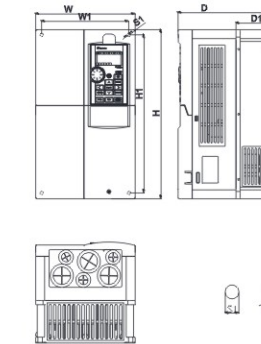

Frame B								
Model type	W (mm)	W1 (mm)	H (mm)	H1 (mm)	D (mm)	D1 (mm)	S1 (mm)	S2 (mm)
SA3-043-7.5K/11KF	190.0	173.0	320.0	303.0	190.0	80.5	8.5	8.5
SA3-043-11K/15KF								
SA3-043-15K/18.5KF								
SA3-023-5.5K/7.5KF								
SA3-023-7.5K/11KF								
SA3-023-11K/15KF								

Frame C

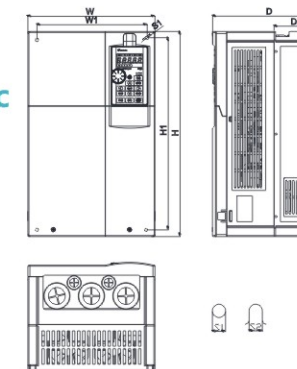

Frame C								
Model type	W (mm)	W1 (mm)	H (mm)	H1 (mm)	D (mm)	D1 (mm)	S1 (mm)	S2 (mm)
SA3-043-18.5K/22KF	250.0	231.0	400.0	381.0	210.0	89.5	8.5	8.5
SA3-043-22K/30KF								
SA3-043-30K/37KF								
SA3-023-15K/18.5KF								
SA3-023-18.5K/22KF								

Dimensions

Frame D

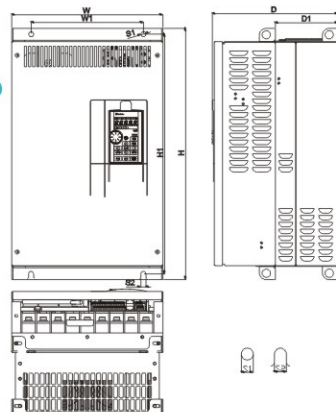

Frame D									
Model type	W (mm)	W1 (mm)	H (mm)	H1 (mm)	D (mm)	D1 (mm)	S1 (mm)	S2 (mm)	
SA3-043-37K/45KF	330.0	245.0	550.0	525.0	275.0	137.5	11.0	11.0	
SA3-043-45K/55KF									
SA3-043-55K/75KF									
SA3-043-75K/90KF									
SA3-023-22K/30KF									
SA3-023-30K/37KF									
SA3-023-37K/45KF									

Frame E

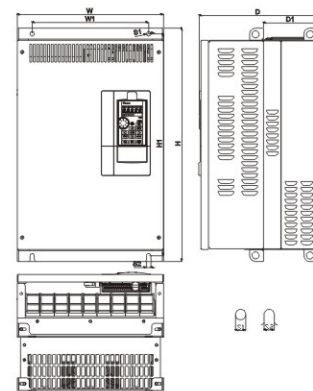

Frame E									
Model type	W (mm)	W1 (mm)	H (mm)	H1 (mm)	D (mm)	D1 (mm)	S1 (mm)	S2 (mm)	
SA3-043-90K/110KF	370.0	295.0	589.0	560.0	300.0	137.5	11.0	11.0	
SA3-043-110K/132KF									
SA3-023-45K/55KF									
SA3-023-55K/75KF									

Frame F

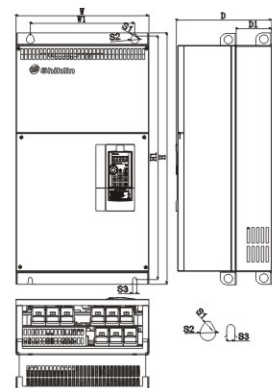

Frame F									
Model type	W (mm)	W1 (mm)	H (mm)	H1 (mm)	D (mm)	D1 (mm)	S1 (mm)	S2 (mm)	S3 (mm)
SA3-043-132K/160KF	420.0	340.0	800.0	770.0	300.0	145.5	13.0	25.0	13.0
SA3-023-75K/90KF									

Dimensions

Frame G

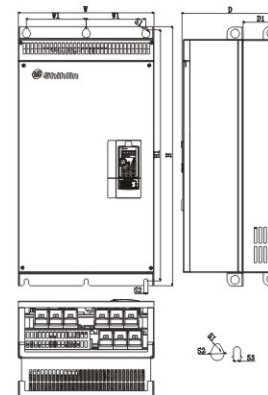

Frame G									
Model type	W (mm)	W1 (mm)	H (mm)	H1 (mm)	D (mm)	D1 (mm)	S1 (mm)	S2 (mm)	S3 (mm)
SA3-043-160K/185KF	500.0	180.0	870.0	850.0	360.0	150.0	13.0	25.0	13.0
SA3-043-185K/220KF									
SA3-043-220K/250KF									
SA3-043-250K/280KF									
SA3-023-90K/110KF									
SA3-023-110K/132KF									

Frame H

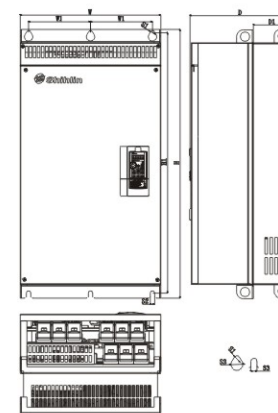

Frame H									
Model type	W (mm)	W1 (mm)	H (mm)	H1 (mm)	D (mm)	D1 (mm)	S1 (mm)	S2 (mm)	S3 (mm)
SA3-043-280K/315KF	600.0	230.0	1000.0	980.0	400.0	181.5	13.0	25.0	13.0
SA3-043-315K/355KF									

SE3 Series

High Performance Vector Control AC Drive

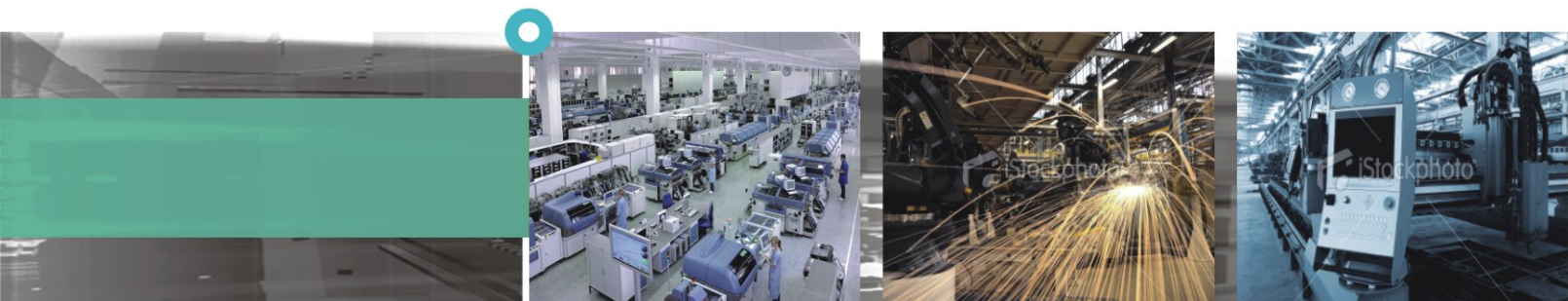

Product Range

Model	KW (HP)	0.4 (0.5)	0.75 (1)	1.5 (2)	2.2 (3)	3.7 (5)	5.5 (7.5)	7.5 (10)	11 (15)	15 (20)	18.5 (25)	22 (30)		
SE3	021	1-Phase 220V	[Shaded]											
	023	3-Phase 220V	[Shaded]											
	043	3-Phase 440V	[Shaded]											

Product Features

High Performance Vector Control Technology

- High starting torque: Sensorless vector control (SVC) 200% 0.5Hz, and closed-loop vector control (FOC + PG) 180% 0Hz.

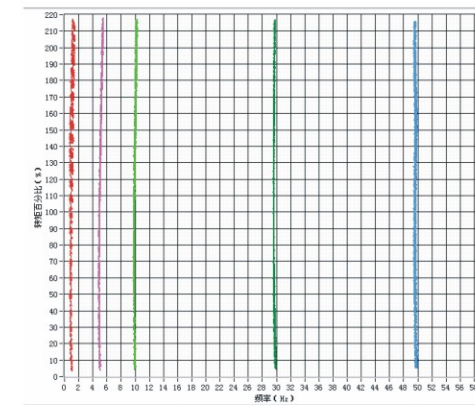

High output frequency 0~1500Hz

- Support high speed spindle function, which can be applied to complicated and precise machining process. The application includes high-speed drilling machine, engraving machine, centrifuge equipment.

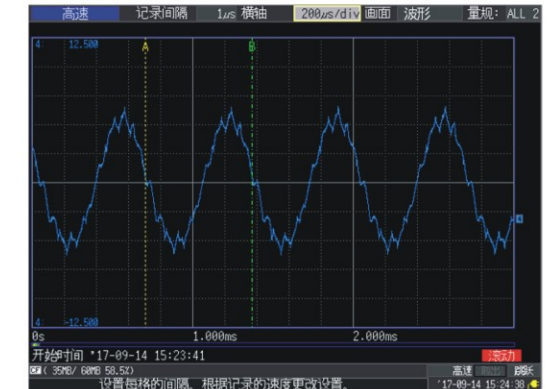

High Performance Synchronous Motor Control Technology

- Supports induction motor (IM) and synchronous motor (IPM and SPM) control.



Support multiple high-speed bus connections

- Equipped with high-speed communications: CANopen, Profibus, DeviceNet, EtherCAT, MODBUS TCP;



Product Features

Supports Multiple Control Modes for Different Applications

· Built in position control, speed control, and tension control functions.
Through IO switching, multiple control functions can be applied to speed, torque, and position controls.
Position control function supports home position return mode, zero servo control, and Pr/Pt modes. (Selective options: PG301C, PG301L, PG302L)A

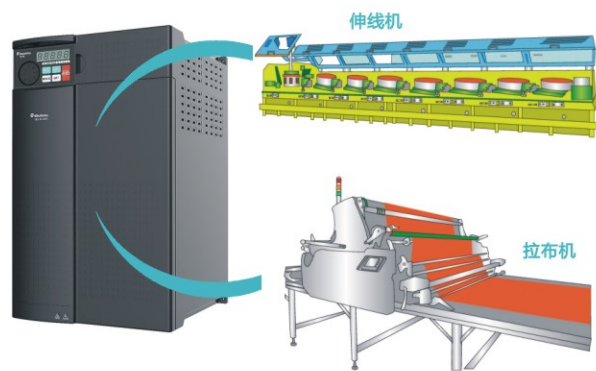

Low-noise Carrier Wave Control (Soft-PWM)

· Motor noise is controlled so that the metallic sound is transformed into a more pleasing buzz.
Low noise operations to reduce the interference exerted upon external radio frequencies

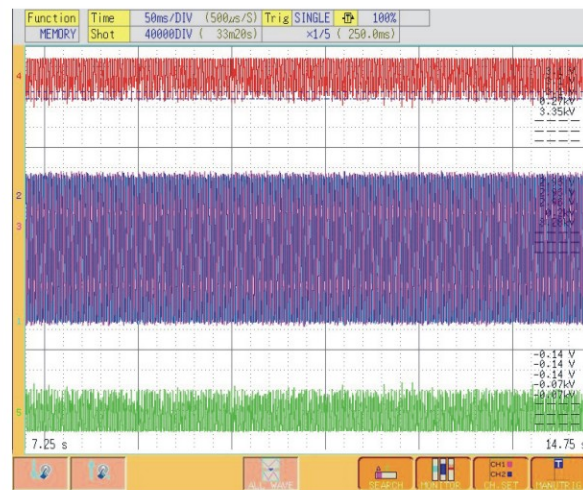

High Overload Capacity

· Significantly improved overload capacity to 150% for 60 seconds and 200% for 3 seconds, making it suitable for tooling machinery applications that requires the ability to handle sudden load changes.

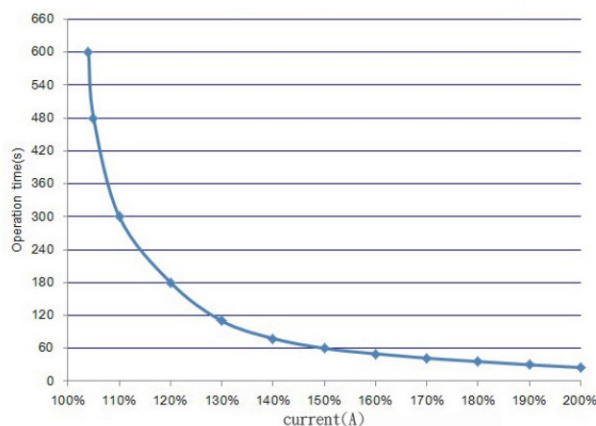

RFI filter has been built in all the products

· Built in RFI filter in SE3 series, which reduces electromagnetic interference effectively.

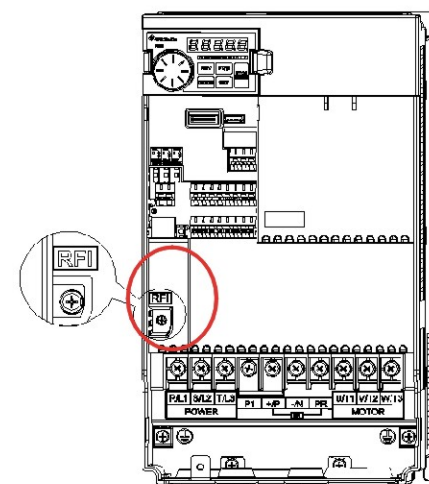

Product Features

Isolated Air Channel

· Fan wind channels are sealed and isolated from the heat dissipation system and electrical parts. Dust will not be able to infiltrate the interior of the machine through the fans.

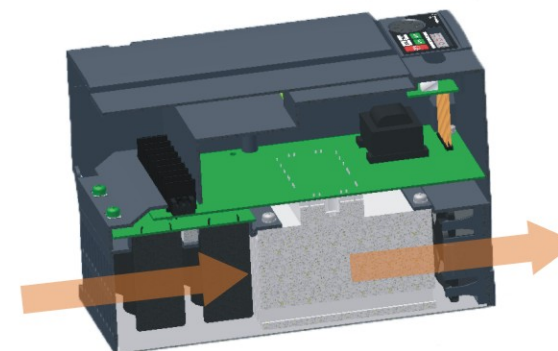

LED Operation Interface

1. 5 Digit LED display
2. 7 Digit LED display light
3. Subsided shuttle knob
4. Easy for operation



12 Sets of Alarm Records

· Complete alarm system for recording the output frequency, output current, output voltage, accumulated count of temperature increase, PN voltage, total AC drive operation time, AC drive operational status, alarm output time. A total of 12 alarm code, 12 groups of alarm code.

Parameter	Name	Factory Value	Setting Range	Content	
P.288	06-40	Alarm code query	0~12	0	176
P.289	06-41	Alarm code display	Read	Read	176
P.290	06-42	Alarm code query	0~10	0	176
P.291	06-43	Alarm code display	Read	Read	176

Protection System Improvement

· Output phase failure protection, Over-current protection, over-voltage protection, under-voltage protection, motor over-heat protection, IGBT module over-heat protection, communication abnormality protection.

Parameter	Name	Factory Value	Setting Range	Content
06-18 P.280	Short circuit detection when starting	0	0	No Short circuit detection when starting when starting
			1	Short circuit detection when starting
06-19 P.282	Short circuit detection when in the operation	50.0%	0~100.0%	---

(Above : Short circuit protection , Control the starter end of the short circuit detection and set the detection level.)

Easy for communication wiring

· Standard RJ45 network and DA+ , DB EU terminals are equipped, which allows communication wiring by multiple devices.

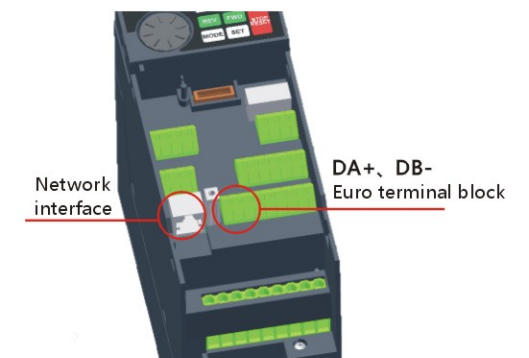

Built-in PLC Functions

· Provides PLC programming software, easy for editing.
· Applicable for programming small number of points, and support multiple functions.

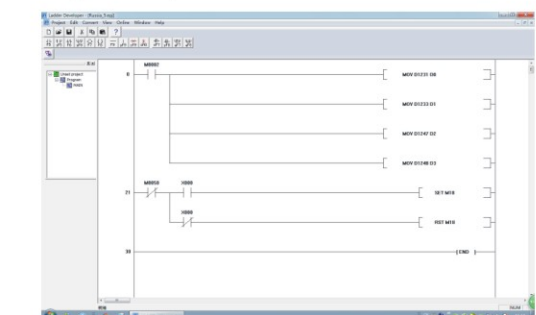

Product Features

Parameter grouping, easy for debug

· Parameter grouping, easy for debug

Parameter Group	Parameter NO.	Parameter Name	Setting Range	Factory	User setting
02-10	P.60	2-5filter time	0~2000ms	30ms	
02-11	P.139	The bias rate og 2-5 voltage signal	0~100.0%	0	
02-12	P.192	The minimum input positive voltage of 2-5	0~10.00V	0	
02-13	P.193	The maximum input positive voltage of 2-5	0~10.00V	10.00V	
02-14	P.194	The percentage corresponding to the The minimum input positive voltage of terminal 2-5	-100.0%~100.0%	0%	
02-15	P.195	The percentage corresponding to the The maximum input positive voltage of terminal 2-5	-100.0%~100.0%	100.0%	

Previous design: It is inconvenient for set up while parameters are not in order.
SE3 model: After grouping relative functions, it is easier for set up.

Easy to disassemble the fan

· The fan design of AC drive is on the top of SE3 which can reduce dusts effectively.
· The screwless wiring will not affect daily maintenance of the fan.



Applicable Industries



Air Compressor



Injection molding machine



Toolroom machine



Engraving Machine



PCB High speed drilling Machine



Centrifugal Machine

Electrical Specifications

220V series one-phase/three-phase

Frame		A		B		
ModelSE3-021- [] - xy		0.4K	0.75K	1.5K	2.2K	
Output	HD	Rated output capacity (kVA)	1	1.5	3.2	4.2
		Rated outputcurrent (A)	2.7	4.5	8	11
		Applicable motor capacity (HP)	0.5	1	2	3
		Applicable motor capacity (kW)	0.4	0.75	1.5	2.2
		Overload current rating	150% 60 seconds 200% 3seconds (inverse time characteristics)			
	Carrier frequency (kHz)	1~15KHz				
	ND	Rated outputcapacity (kVA)	1.2	2	3.4	4.8
		Rated outputcurrent (A)	3	5	8.5	12.5
		Applicable motor capacity (HP)	0.5	1	2	3
		Applicable motor capacity (kW)	0.4	0.75	1.5	2.2
Overload current rating		120% 60seconds (inverse time characteristics)				
Carrier frequency (kHz)	1~15KHz					
Maximum output voltage		Three-phase 200-240V				
Power supply	Rated power voltage	One-phase 200-240V 50Hz / 60Hz				
	Power voltage permissible fluctuation	One-phase 170-264V 50Hz / 60Hz				
	Power frequency permissible fluctuation	±5%				
	Power source capacity (kVA)	1.5	2.5	4.5	6.9	
Cooling method		Self cooling		Forced air cooling		
Inverter weight (kg)		1.0	1.0	1.5	1.5	

Frame		A		B		C		D			
ModelSE3-023- [] - xy		0.4K	0.75K	1.5K	2.2K	3.7K	5.5K	7.5K	11K	15K	
Output	HD	Rated output capacity (kVA)	1.2	2	3.2	4.2	6.7	9.5	12.5	18.3	24.7
		Rated outputcurrent (A)	3	5	8	11	17.5	25	33	49	65
		Applicable motor capacity (HP)	0.5	1	2	3	5	7.5	10	15	20
		Applicable motor capacity (kW)	0.4	0.75	1.5	2.2	3.7	5.5	7.5	11	15
		Overload current rating	150% 60 seconds 200% 3seconds (inverse time characteristics)								
	Carrier frequency (kHz)	1~15KHz									
	ND	Rated outputcapacity (kVA)	1.3	2.1	3.4	4.8	7.4	10.3	13.7	19.4	26.3
		Rated outputcurrent (A)	3.2	5.5	8.5	12.5	19.5	27	36	51	69
		Applicable motor capacity (HP)	0.5	1	2	3	5	7.5	10	15	20
		Applicable motor capacity (kW)	0.4	0.75	1.5	2.2	3.7	5.5	7.5	11	15
Overload current rating		120% 60seconds 150% 3seconds (inverse time characteristics)									
Carrier frequency (kHz)	1~15KHz										
Maximum output voltage		Three-phase 200-240V									
Power supply	Rated power voltage	Three-phase 200-240V 50Hz / 60Hz									
	Power voltage permissible fluctuation	Three-phase 170-264V 50Hz / 60Hz									
	Power frequency permissible fluctuation	±5%									
	Power source capacity (kVA)	1.5	2.5	4.5	6.4	10	12	17	20	28	
Cooling method		Forced air cooling									
Inverter weight (kg)		1.0	1.0	1.0	1.5	1.5	4.0	4.1	5.7	5.8	

Note: The test conditions of rated output current, rated output capacity and frequency converter inverter power consumption are: the carrier frequency (P.72) is at the set value; the frequency converter/inverter output voltage is at 220V; the output frequency is at 60Hz, and the ambient temperature is 40°C.

Electrical Specifications

440V series three-phase													
Frame		A			B			C			D		
Model SE3-043- [] - xy		0.4K	0.75K	1.5K	2.2K	3.7K	5.5K	7.5K	11K	15K	18.5K	22K	
Output	HD	Rated output capacity (kVA)	1	2	3	4.6	6.9	10	14	18	25	29	34
		Rated output current (A)	1.5	2.7	4.2	6	9	12	17	24	32	38	45
		Applicable motor capacity (HP)	0.5	1	2	3	5	7.5	10	15	20	25	30
		Applicable motor capacity (kW)	0.4	0.75	1.5	2.2	3.7	5.5	7.5	11	15	18.5	22
		Overload current rating	150% 60 seconds 200% 3seconds (inverse time characteristics)										
	Carrier frequency (kHz)	1~15KHz											
	ND	Rated output capacity (kVA)	1.4	2.3	3.5	5	8	12	15.6	21.3	27.4	31.6	37.3
		Rated output current (A)	1.8	3	4.6	6.5	10.5	15.7	20.5	28	36	41.5	49
		Applicable motor capacity (HP)	0.5	1	2	3	5	7.5	10	15	20	25	30
		Applicable motor capacity (kW)	0.4	0.75	1.5	2.2	3.7	5.5	7.5	11	15	18.5	22
Overload current rating		120% 60seconds (inverse time characteristics)											
Carrier frequency (kHz)	1 ~ 15KHz												
Maximum output voltage	Three-phase 380-480V												
Power supply	Rated power voltage	Three-phase 380-480V 50Hz / 60Hz											
	Power voltage permissible fluctuation	Three-phase 323-528V 50Hz / 60Hz											
	Power frequency permissible fluctuation	±5%											
	Power source capacity (kVA)	1.5	2.5	4.5	6.9	10.4	11.5	16	20	27	32	41	
Cooling method	Self cooling	Forced air cooling											
Inverter weight (kg)	1.0	1.0	1.0	1.5	1.5	3.9	4.0	4.0	5.7	5.8	5.8		

Note: The test conditions of rated output current, rated output capacity and frequency converter inverter power consumption are: the carrier frequency (P.72) is at the set value; the frequency converter/inverter output voltage is at 440V; the output frequency is at 60Hz, and the ambient temperature is 40°C.

Common Specifications

Control method	SVPWM control, V/F control, close-loop V/F control (VF+PG), general flux vector control, sensorless vector control (SVC), close-loop vector control (FOC+PG), torque control (TQC+PG).	
Output frequency range	0~1500.00Hz	
Frequency setting resolution	Digital setting	The resolution is 0.01Hz.
	Analog setting	0.01Hz/60Hz(terminal 2: -10~+10V / 13bit) 0.15Hz/60Hz(terminal 2: 0~±10V / 12bit) 0.03Hz/60Hz(terminal 2: 0~5V / 11bit) 0.06Hz/60Hz(terminal 4: 0~10V, 4~20mA / 12bit) 0.12Hz/60Hz(terminal 4: 0~5V / 11bit)
Output frequency accuracy	Digital setting	Maximum target frequency±0.01%.
	Analog setting	Maximum target frequency±0.1%.
Speed control range	IM: When SVC, 1:200; when FOC+PG, 1:1000. PM: When SVC, 1:20; when FOC+PG, 1:1000.	
Start torque	200% 0.5 Hz	
V/f characteristics	Constant torque curve, variable torque curve, five-point curve, VF separation	
Acceleration / deceleration curve characteristics	Linear acceleration / deceleration curve, S pattern acceleration / deceleration curve	
Drive motor	Induction motor(IM), permanent magnet motor(SPM, IPM)	
Stalling protection	The stalling protection level can be set to 0~250%	
Target frequency setting	Parameter unit setting, DC 0~5V/10V signal, DC -10~+10V signal, DC 4~20 mA signal, multiple speed stage level setting, communication setting, HDI setting.	
PID control	Please refer to parameter description	
Built-in simple PLC	Supports 21 basic instructions and 14 application instructions, including PC editing software;	
Parameter unit	Operation monitoring	Output frequency, output current, output voltage, PN voltage, output torque, electronic thermal accumulation rate, temperature rising accumulation rate, output power, Analog value input signal, digital input and output terminal status...; alarm signal and alarm history 12 groups at most
	LED indication lamp (7)	Forward rotation indication lamp, reverse rotation indication lamp, frequency monitoring indication lamp, mode switch indication lamp, PU control indication lamp, PLC indication lamp and work indication lamp
Communication function	Built-in Shihlin/Modbus communication protocol, can select MODBUS TCP, CANopen, Profibus, DeviceNet, EtherCAT, high speed card	
Protection mechanism / alarm function	Output short circuit protection, Over-current protection, over-voltage protection, under-voltage protection, motor over-heat protection, IGBT module over-heat protection, communication abnormality protection,	
Environment	Ambient temperature	Heavy load : -10 ~ +50°C (non-freezing) , Light load : -10 ~ +40°C (non-freezing), please refer to 3.4.2 Class of protection and operation temperature for details.
	Ambient humidity	Below 90%Rh (non-condensing).
	Storage temperature	-20 ~ +65°C.
	Surrounding environment	Indoor, no corrosive gas, no flammable gas, no flammable powder.
	Altitude	Altitude below 2000 meters, when altitude is above 1,000 m, derate the rated current 2% per 100 m
	Vibration	Vibration below 5.9m/s ² (0.6G).
	Grade of protection	IP20
	The degree of environmental pollution	2
Class of protection	Class I	
International certification	CE	

Wiring Diagram

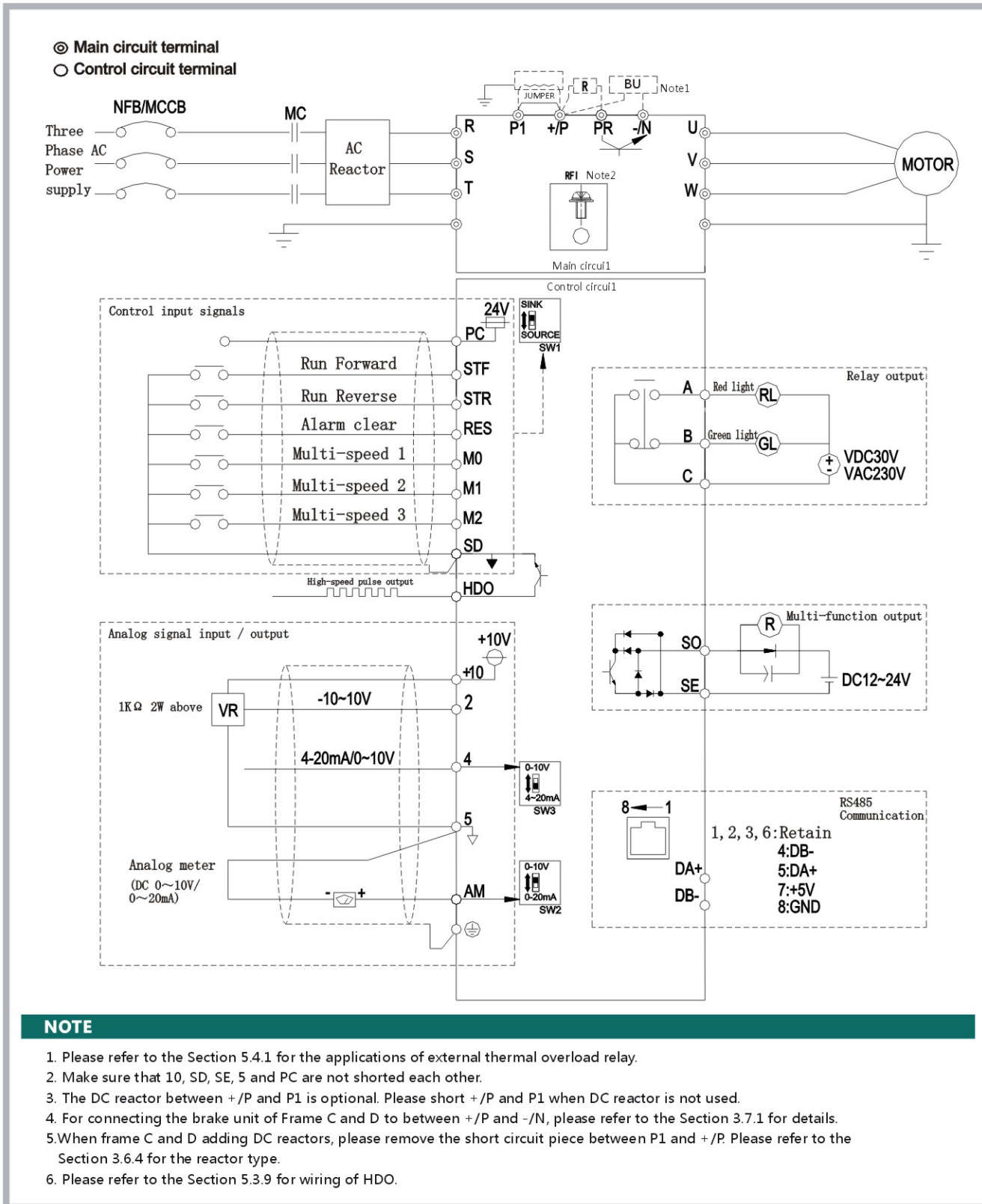

Dimensions

Frame A

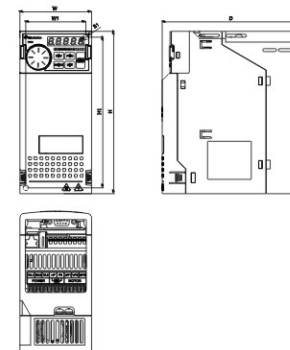

单位 : mm

Frame A						
Model type	W (mm)	W1 (mm)	H (mm)	H1 (mm)	D (mm)	S1 (mm)
SE3-043-0.4~1.5K	62.0	74.0	167.0	155.0	144.0	5.2
SE3-023-0.4~1.5K						
SE3-021-0.4~0.75K						

Frame B

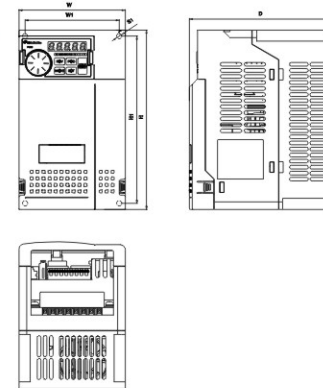

Frame B						
Model type	W (mm)	W1 (mm)	H (mm)	H1 (mm)	D (mm)	S1 (mm)
SE3-043-2.2~3.7K	105.0	93.0	178.0	166.0	146.0	5.2
SE3-023-2.2~3.7K						
SE3-021-1.5~2.2K						

Frame C

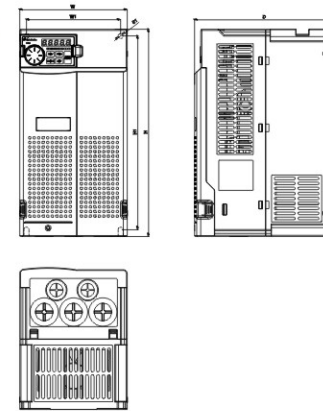

Frame C						
Model type	W (mm)	W1 (mm)	H (mm)	H1 (mm)	D (mm)	S1 (mm)
SE3-043-5.5~11K	141.0	123.6	270.0	252.6	185.0	6.5
SE3-023-5.5~7.5K						

Frame D

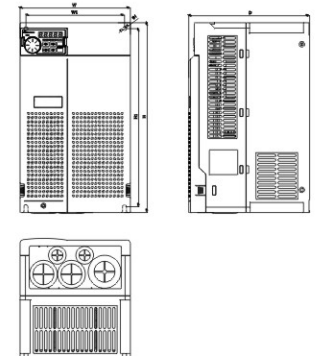

Frame D						
Model type	W (mm)	W1 (mm)	H (mm)	H1 (mm)	D (mm)	S1 (mm)
SE3-043-15~22K	175.0	156.4	300.0	281.4	191.8	6.2
SE3-023-11~15K						

SC3 Series

Compact AC Drive



Product Range

Model	KW (HP)	0.2 (0.25)	0.4 (0.5)	0.75 (1)	1.5 (2)	2.2 (3)	3.7 (5)	5.5 (7.5)	
SC3	021	1-phase 220V							
	023	3-phase 220V							
	043	3-phase 440V							

Main Features

- * Frequency output: 0 ~ 650Hz
- * Starting torque: 180%/ 3Hz
- * Reasonable absorb circuit and element match, and effectively decrease the low induction voltage by 50%.
- * Built-in RFI filter
- * Excellent vibration resistant ability
- * Reduce 20% low-frequency noise comparing with SS2
- * Easy to operate with optimized knob

Applications

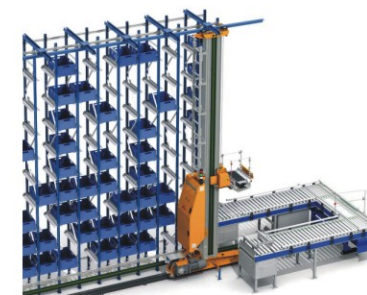

Automated Storage



Sealing Machine



Band-sawing Machine



Pressure Fan



Noodle Machine



Slicer

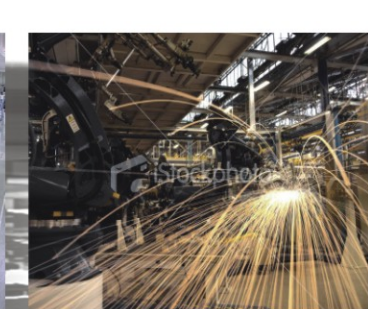

SC3

Product Features

RFI filter has been built in all the products

- Built in RFI filter in SE3 series, which controls electromagnetic interference effectively.

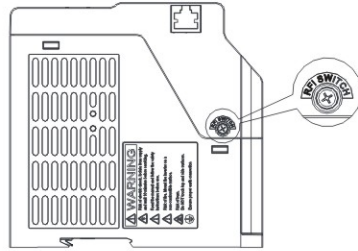

Note: For conforming to the CE specifications, please refer to the operation manual to finish the installation and distribution.

Coating& Isolated air duct

- Each circuit board has with insulating liquids coatings.
- Dissipation air duct was completely isolated, which forces the air current only flows through the surface of the radiator, and will not blow dust and oil gas into the inverter.

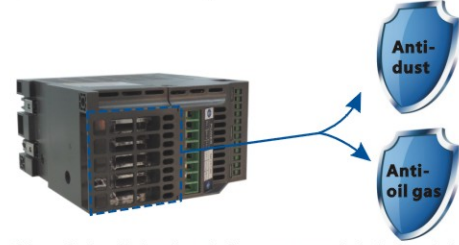

Note: Although the dissipation air duct was completely isolated, dust and oil gas would still blow into the converter with natural air current if the converter was installed in a heavy dust and oil gas environment without any protection for a long time.

Easy to install -- wiring communication

- Easy to connect the operator
- Convenient for multi-machine wiring communication

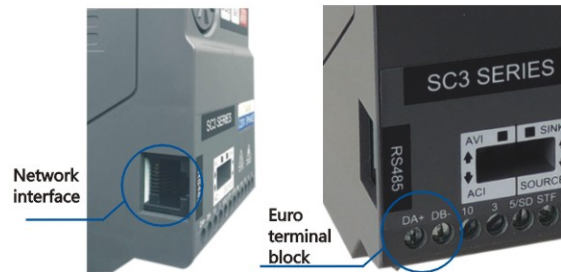

Note: Pulling operator can not be used at the same time with RS485.

Easy to disassemble the fan.

- The fan design of AC drive is on the top of SC3 which can reduce dusts effectively.
- The screwless wiring will not affect daily maintenance of the fan.



Update the operability of Jog dial

- Update the structure of Jog dial: The jog dial do not protrude from the surface of the product, It is difficult to damage and is easy to manipulate during quick spinning adjusting.



Parameter grouped - easier to debug

Parameter Group	Parameter NO.	Parameter Name	Setting Range	Factory
01-00	P.1	Upper limit frequency	0 ~ 120.00Hz	120.00Hz
01-01	P.2	Lower limit frequency	0 ~ 120.00Hz	0Hz
01-02	P.18	High speed upper limit frequency	120.00 ~ 650.00Hz	120.00Hz
01-03	P.3	Base frequency	50Hz System set : 0 ~ 650.00Hz	50Hz
			60Hz System set : 0 ~ 650.00Hz	60Hz
01-04	P.19	Base Voltage	0 ~ 1000.0V 99999 : Change with input voltage	99999

Previous Product: Parameter numbers were not in order and it was difficult to set.

SC3 system: Similar functions were put in the same group, which make it easier to set.

Electrical Specifications

220V Series single-phase

Frame		A			B	
ModelS SC3-021-□□□K-□□		0.2	0.4	0.75	1.5	2.2
Output	Rated output capacity (kVA)	0.6	1	1.5	2.5	4.2
	Rated output current (A)	1.8	2.7	4.5	8	11
	Applicable motor capacity (HP)	0.25	0.5	1	2	3
	Applicable motor capacity (kW)	0.2	0.4	0.75	1.5	2.2
Overload current rating		150% 60seconds 200% 1second (inverse time characteristics)				
Carrier frequency (kHz)		1~15kHz				
Maximum output voltage		Three-phase 200-240V				
Power supply	Rated power voltage	Single-phase 200-240V 50Hz / 60Hz				
	Power voltage permissible fluctuation	Single-phase 170-264V 50Hz / 60Hz				
	Power frequency permissible fluctuation	±5%				
	Power source capacity (kVA)	0.75	1.5	2.5	3.5	6.4
Cooling method		Self cooling	Forced air cooling			
Weight (kg)		0.66	0.68	0.73	1.38	1.4

220V Series three-phase

Frame		A			B		
ModelS SC3-023-□□□K-□□		0.2	0.4	0.75	1.5	2.2	3.7
Output	Rated output capacity (kVA)	0.6	1.2	2	3.2	4.2	6.7
	Rated output current (A)	1.8	3	5	8	11	17.5
	Applicable motor capacity (HP)	0.25	0.5	1	2	3	5
	Applicable motor capacity (kW)	0.2	0.4	0.75	1.5	2.2	3.7
Overload current rating		150% 60seconds 200% 1second (inverse time characteristics)					
Carrier frequency (kHz)		1~15kHz					
Maximum output voltage		Three-phase 200-240V					
Power supply	Rated power voltage	Three-phase 200-240V 50Hz / 60Hz					
	Power voltage permissible fluctuation	Three-phase 170-264V 50Hz / 60Hz					
	Power frequency permissible fluctuation	±5%					
	Power source capacity (kVA)	0.75	1.5	2.5	4.5	6.4	10
Cooling method		Self cooling	Forced air cooling				
Weight (kg)		0.69	0.69	0.70	0.73	1.32	1.4

Electrical Specifications

440V Series three-phase						
Frame	A			B		
ModelS SC3-043-□□□K-□□	0.4	0.75	1.5	2.2	3.7	5.5
Rated output capacity (kVA)	1	2	3	4.6	6.9	9.2
Rated output current (A)	1.5	2.6	4.2	6	9	12
Applicable motor capacity (HP)	0.5	1	2	3	5	7.5
Applicable motor capacity (kW)	0.4	0.75	1.5	2.2	3.7	5.5
Overload current rating	150% 60seconds 200% 1second (inverse time characteristics)					
Carrier frequency (kHz)	1~15kHz					
Maximum output voltage	Three-phase 380-480V					
Rated power voltage	Three-phase 380-480V 50Hz / 60Hz					
Power voltage permissible fluctuation	Three-phase 323-528V 50Hz / 60Hz					
Power frequency permissible fluctuation	±5%					
Power source capacity (kVA)	1.5	2.5	4.5	6.9	10.4	11.5
Cooling method	Self cooling	Forced air cooling				
Weight (kg)	0.74	0.74	0.81	1.37	1.37	1.42

Common Specifications

Control method	SVPWM control,V/F control,General magnetic vector control	
Output frequency range	0~650.00Hz	
Frequency setting resolution	Digital setting	The frequency is set within 100Hz,the resolution is 0.01Hz. The frequency is set more than100Hz,the resolution is 0.1Hz.
	Analog setting	DC 0~5V or 4~20mA signal, 11 bit DC 0~10V signal, 12 bit
Output frequency accuracy	Digital setting	Maximum target frequency±0.01%.
	Analog setting	Maximum target frequency±0.1%.
Start torque	180% 3Hz,200% 5Hz:Under the condition of general magnetic vector control	
V/Fcharacteristics	Constant torque curve, variable torquecurve, five-point curve	
Acceleration / deceleration curve characteristics	Linear acceleration /deceleration curve, S pattern acceleration /deceleration curve1 & 2 & 3	
Drive motor	Induction motor(IM)	
Stall current protection	The stalling protection level can be set to 0~ 250%(06-01(P.22)). The default value is 200%.	
Target frequency setting	Operation panel setting, DC 0~5V/10V signal, DC 4~20 mA signal, multiple speed stage level setting, communication setting.	
Operation panel	Operation monitoring	Output frequency, output current, output voltage, PN voltage, electronic thermal accumulation rate, temperature rising accumulation rate, output power, analog value input signal, output terminal status...; alarm history 12 groups at most, the last group of alarm message is recorded.
	LED indication lamp (6)	frequency monitoring indication lamp, voltage monitoring indication lamp, current monitoring indication lamp, motor operation lamp, mode switching lamp, PU control indication lamp.
Communication function	RS-485 communication can select Shihlin/Modbus communication protocol, communication speed115200bps or lower.	
Protection mechanism / alarm function	Output short circuit protection, Over-current protection, over-voltage protection, under-voltage protection, motor over-heat protection (06-00(P.9)), IGBT module over-heat protection, communication abnormality protection,etc.	
Environment	Ambient temperature	-10 ~ +50°C (non-freezing)
	Ambient humidity	Below 90%Rh (non-condensing).
	Storage temperature	-20 ~ +65°C.
	Surrounding environment	Indoor, no corrosive gas, no flammable gas, no flammable powder.
	Altitude	Altitude is below 2000 meters. When altitude is above 1,000 m,derate the rated current 2% per 100 m
	Vibration	Vibration below 5.9m/ s ² (0.6G).
	Grade of protection	IP20
	The degree of environmental pollution	II
Class of protection	Class I	
International certification	CE	

Wiring Diagram

- ⊙ Main circuit terminal
- Control circuit terminal

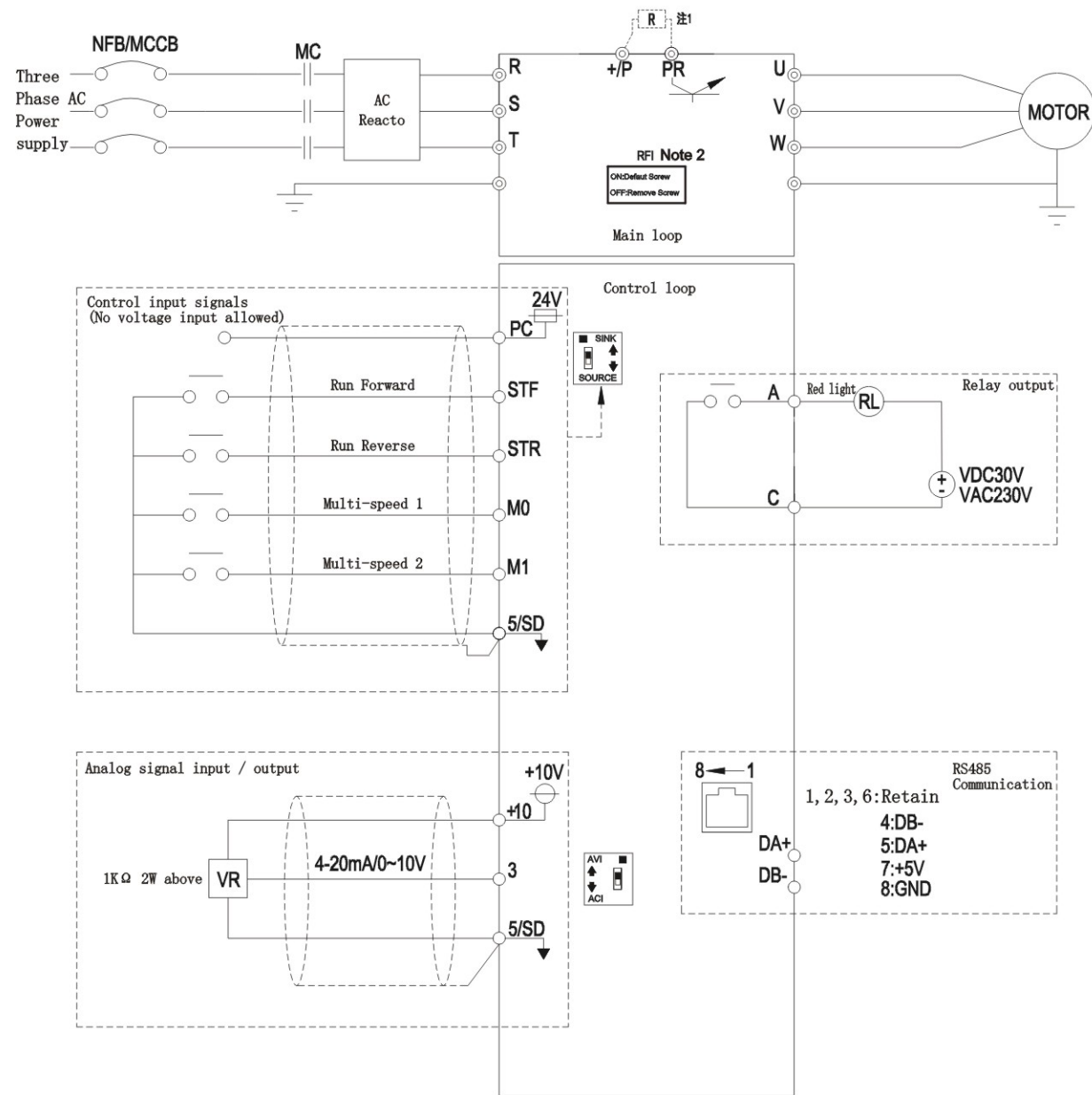

NOTE

- 1 : SC3-043-0.4K~1.5K , SC3-023-0.2~1.5K , SC3-021-0.2~0.75K don't have + / P and PR terminals.
- 2 : Full range of built-in RFI filter to suppress electromagnetic interference, but if you want to meet CE standard, please refer to the instructions in the operating manual for installation.

Dimensions

Frame A

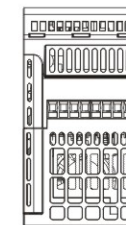
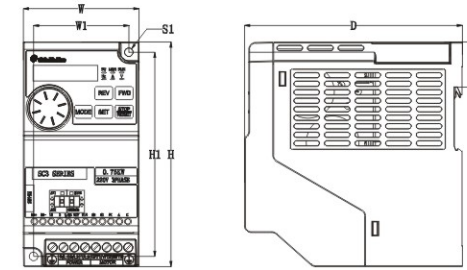

Frame A

Model type	W (mm)	W1 (mm)	H (mm)	H1 (mm)	H2 (mm)	D (mm)	S1 (mm)
SC3-021-0.2K	68	56	132	120	26.5	128	5
SC3-021-0.4K							
SC3-021-0.75K							
SC3-023-0.2K							
SC3-023-0.4K							
SC3-023-0.75K							
SC3-023-1.5K							
SC3-043-0.4K							
SC3-043-0.75K							
SC3-043-1.5K							

Frame B

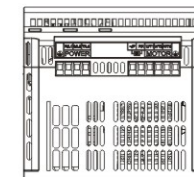
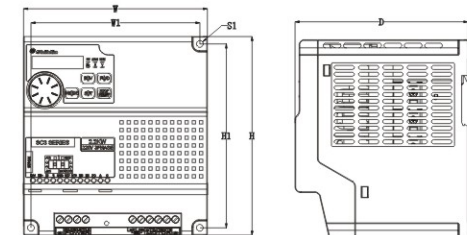

Frame A

Model type	W (mm)	W1 (mm)	H (mm)	H1 (mm)	H2 (mm)	D (mm)	S1 (mm)
SC3-021-1.5K	136	125	147	136	26.5	128	5
SC3-021-2.2K							
SC3-023-2.2K							
SC3-023-3.7K							
SC3-043-2.2K							
SC3-043-3.7K							
SC3-043-5.5K							

SS2 Series

Compact Design
Vector Control AC Drive



Product Range

Model	KW (HP)	0.4 (0.5)	0.75 (1)	1.5 (2)	2.2 (3)	3.7 (5)	5.5 (7.5)	
SS2	021	[Shaded]					[Shaded]	[Shaded]
	023	[Shaded]					[Shaded]	[Shaded]
	043	[Shaded]						

Main Features

- * Built-in shuttle knob to adjust output frequency and set parameters easily
- * Built-in RS-485 communication interface
- * Support MODBUS and Shihlin communication protocol
- * Built-in proportion linkage control function to support multi inverters connection
- * Maximum 650Hz frequency output
- * Support DIN rail mount
- * The resolution of frequency setting: digital 0.01Hz ; analog 1/1000
- * The accuracy of output frequency: 0.01%
- * Multi-function input/output terminals
- * Support 2 analog setting types: 0-10V and 4-20mA

Application

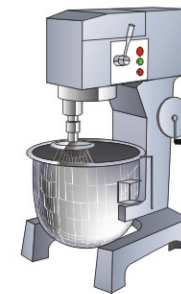

Mixer Machine

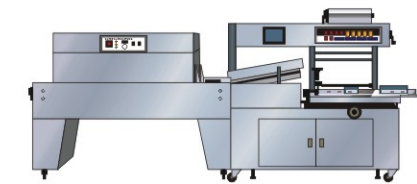

Packing Machine



Constant pressure Water supply

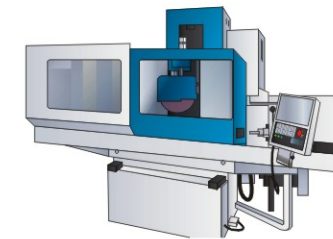

Grinding Machine



Desktop type lathe

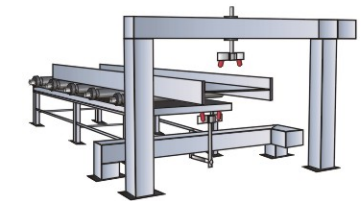

Printing press

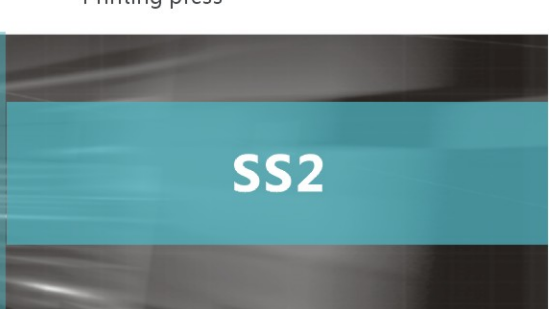
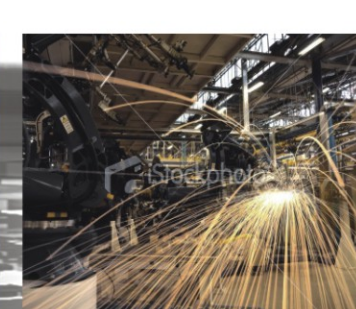

SS2

Product Features

General flux vector control technique

- General flux vector control technique
- A 32-bit RISC CPU for high-speed computation.
- Starting torque, 150%3Hz

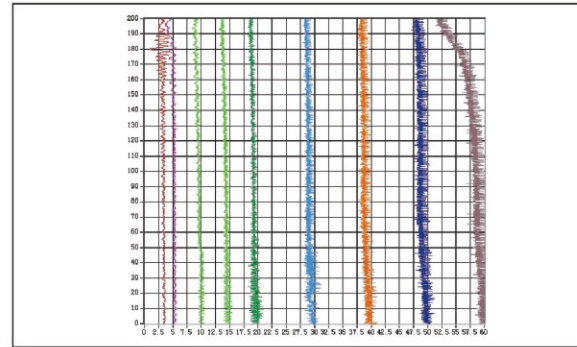

- Speed accuracy is within 1% (0%~100% loading changes)

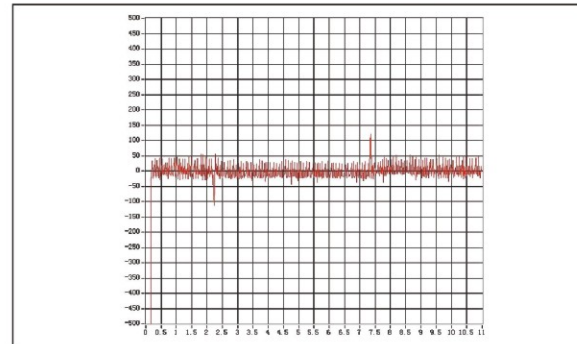

- Motor parameter auto-tuning function
- Stalling protection level reaches to 250%.

High performance and function

- The maximum output frequency up to 650Hz
- Soft-PWM functions for eliminating motor noises and preventing the temperature of AC drive module too high.
- Built-in energy-saving control function, the AC drive will control the output voltage automatically in order to reduce the output power losses when the AC drive is running.
- Cooling fan operation method is selectable.

Built-in proportion linkage function

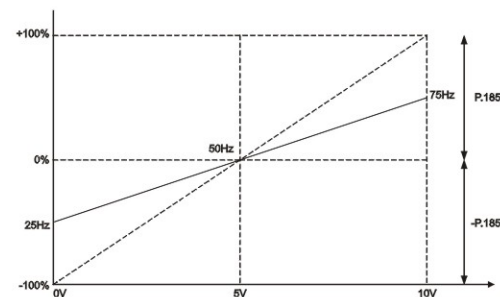

PID feedback control function

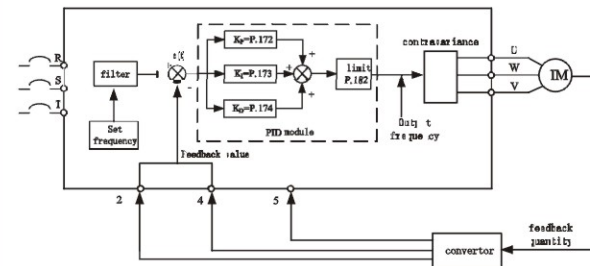

Triangular wave function (traverse)

- This is suitable for operations that need traversing and winding movements such as textile operations.

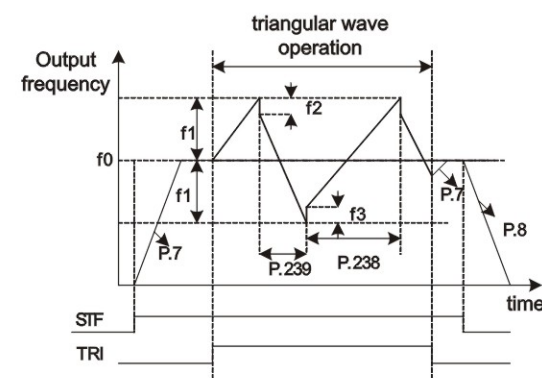

- f0: Setting value of frequency
- f1: Generated amplitude for setting frequency ($f_0 \times P.235$)
- f2: Compensation from acceleration to deceleration ($f_1 \times P.236$)
- f3: Compensation from deceleration to acceleration ($f_1 \times P.237$)

Built-in frequency and parameter setting knob



Product Features

PWM control function

- The operating frequency can be controlled with the PWM signals output from PLC.
- The terminal M2 can be set as PWM signal input.

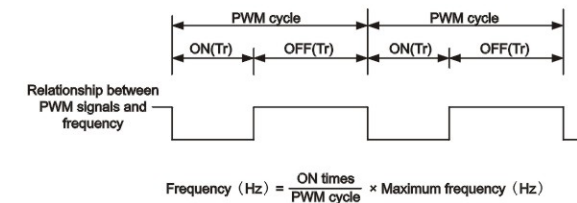

Programmed operation mode with manually operated

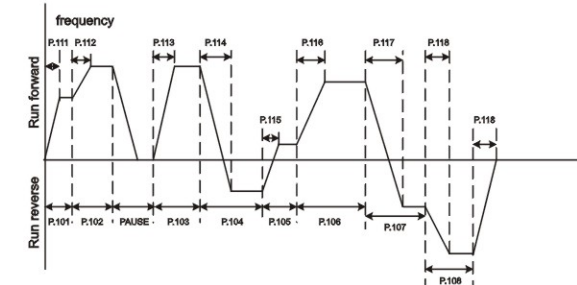

Equipped with grid power frequency switching mechanism

- It provides automatic switch between the grid power and frequency conversion.
- If the motor is running at rated frequency, using grid power frequency has a much better efficiency.
- In order to prevent the motor from stopping for a long time during the maintenance of AC drive, it is recommended AC drive to have grid power switching function.

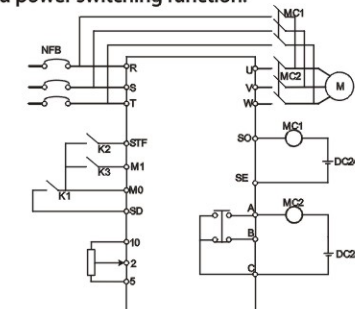

Easy to install design

- Din rail design-Multiple AC drives can be mounted side-by-side in the panel.



- Built-in standard RJ45 port for RS485 communication.
- Screwless terminal blocks designed



- The cooling fan is removable and easy to clean.

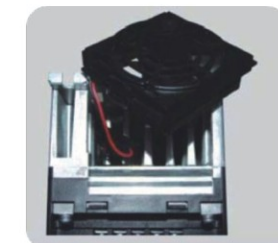

Electric Specifications

220V Series Single-Phase

Model SS2-021-□□□K		0.4K	0.75K	1.5K	2.2K
Applicable Motor Capacity	HP	0.5	1	2	3
	kW	0.4	0.75	1.5	2.2
Output	Rated output capacity kVA (Note)	0.95	1.5	2.5	4.2
	Rated output current A (Note)	2.7	4.5	8	11
	Overload current rating	150% 60 seconds; 200% 1 second (inverse time characteristics)			
	Maximum output voltage	3 Phase 200~240V AC			
Power Supply	Rated power voltage	Single phase 200~240V 50Hz / 60Hz			
	Power voltage permissible fluctuation	Single phase 170~264V 50Hz / 60Hz			
	Power frequency permissible fluctuation	±5%			
	Power source capacity kVA	1.5	2.5	3.5	6.4
Cooling Method	Self-cooling	Forced air cooling			
Weight (kg)	1.1	1.2	1.6	1.7	

220V Series Three-Phase

Model SS2-023-□□□K		0.4	0.75	1.5	2.2	3.7
Applicable Motor Capacity	HP	0.5	1	2	3	5
	kW	0.4	0.75	1.5	2.2	3.7
Output	Rated output capacity kVA (Note)	1.2	2	3.2	4.2	6.7
	Rated output current A (Note)	3	5	8	11	17.5
	Overload current rating	150% 60 seconds; 200% 1 second (inverse time characteristics)				
	Maximum output voltage	3 Phase 200~240V AC				
Power Supply	Rated power voltage	3 Phase 200~240V 50Hz / 60Hz				
	Power voltage permissible fluctuation	3 Phase 170~264V 50Hz / 60Hz				
	Power frequency permissible fluctuation	±5%				
	Power source capacity kVA	1.5	2.5	4.5	6.4	10
Cooling Method	Self-cooling	Forced air cooling				
Weight (kg)	1.1	1.2	1.2	1.6	1.7	

440V Series Three-Phase

Model SS2-043-□□□K		0.4	0.75	1.5	2.2	3.7	5.5
Applicable Motor Capacity	HP	0.5	1	2	3	5	7.5
	kW	0.4	0.75	1.5	2.2	3.7	5.5
Output	Rated output capacity kVA (Note)	1	2	3	4.6	6.9	9.2
	Rated output current A (Note)	1.5	2.6	4.2	6	9	12
	Overload current rating	150% 60 Seconds; 200% 1 Second (inverse time characteristics)					
	(reverse time characteristics)	Three-phase 380~480V					
Power Supply	Rated power voltage	3 Phase 380~480V 50Hz / 60Hz					
	Power voltage permissible fluctuation	323~528V 50Hz / 60Hz					
	Power frequency permissible fluctuation	±5%					
	Power source capacity kVA	1.5	2.5	4.5	6.9	10.4	13.8
Cooling Method	Self-cooling	Self-cooling	Forced air cooling				
Weight (kg)	1.1	1.1	1.2	1.6	1.7	1.7	

Note: The test conditions of rated output current, rated output capacity and inverter power consumption are: the carrier frequency (P.72) is at factory setting value; the inverter output voltage is at 220V/440V; the output frequency is at 60Hz, and the ambient temperature is 50°C.

Common Specifications

Control Method	SVPWM control, V/F control, general flux vector control.			
Output Frequency Range	0.1~650Hz (The starting frequency setting range is between 0 and 60Hz).			
Frequency Resolution	Digital setting	If the frequency value is set below 100Hz, the resolution will be 0.01Hz. If the frequency value is set above 100Hz, the resolution will be 0.1Hz.		
	Analog setting	When setting the signal DC 0~5V, the resolution will be 1/500; When setting the signal DC 0~10V or 4~20mA, the resolution will be 1/1000.		
Output Frequency Accuracy	Digital setting	Maximum target frequency ±0.01%.		
	Analog setting	Maximum target frequency ±0.5%.		
Voltage / Frequency output Characteristics	Base voltage (P.19), base frequency (P.3) can be arbitrarily set. Constant torque model and applicable load model can be selected (P.14).			
Start Torque	150% 3Hz, 200% 5Hz: when using the general flux vector control.			
Torque Boost	The torque boost setting range between 0 and 30% (P.0), auto boost, slip compensation.			
Acceleration / Deceleration Curve Characteristics	The resolution (0.01s/0.1s) of acceleration/deceleration time (P.7, P.8) is switched by P.21. The setting range has 0~360s or 0~3600s for selection. And different acceleration/deceleration curve model can be selected by P.29.			
DC Braking	The DC braking action frequency range between 0 and 120Hz (P.10); the DC braking time is 0~60 Seconds (P.11); and the DC braking voltage is 0~30% (P.12). Linear braking and idling braking selection (P.71).			
Stall current protection	The stalling protection level can be set between 0 and 250% (P.22).			
Target Frequency Setting	Operation panel setting, DC 0~5V signal setting, DC 0~10V signal setting, DC 4~20mA signal setting, Multi-speed stage levels setting, communication setting, pulse frequency setting.			
PID Control	Please refer to P.170~P.183 in Chapter 5.			
Multifunction Control Terminals	Motor starting (STF, STR), the second function (RT), '16-speed operation' (RL, RM, RH, REX), external thermal relay (OH), reset (RES), etc. (can be set by the user (P.80~P.84, P.86))			
Multiple Output Terminals	Multi-function output terminals	SO · SE	P.40	Inverter running (RUN), output frequency detection (FU), Up to output frequency (SU), overload detection (OL), zero current detection (OMD), alarm (ALARM), Section detection (PO1), Periodical detection (PO2), and Pause detection (PO3), Inverter output (BP), Commercial power-supply output (GP).
	Multi-function output relay	A · B · C	P.85	
	Analog output	AM · 5		
Operation Panel	Running status monitoring	Output frequency monitoring, output current monitoring, and output voltage monitoring, alarm record.		
	HELP mode	Alarm history monitoring.		
	LED indication lamp(6)	Run indication lamp, frequency monitoring indication lamp, voltage monitoring indication lamp, current monitoring indication lamp, mode switching indication lamp, and PU control indication lamp.		
Communication Function	RS485	Build in RS485 communication, RJ-45 connector.		
Protection Mechanism / Alarm function	Output short circuit protection, Over-current protection, (+P)/(-N) over-voltage protection, under-voltage protection, motor over heat protection (P.9), IGBT module over-heat protection, communication abnormality protection, etc.			
Environmental Condition	Ambient temperature	-10 ~ +50°C (non-freezing), installation side by side -10 ~ +40°C.		
	Ambient humidity	Below 90%Rh (non-condensing)		
	Storage temperature	-20 ~ +65°C		
	Surrounding environment	Indoor, no corrosive gas, no flammable gas, no flammable dust		
	Altitude and vibration	Altitude: below 1000 meters, Vibration: below 5.9m/s ² (0.6G).		
	Grade of protection	IP20		
The degree of environmental pollution	2			
Class of protection	Class I			
Certification	CE			

Wiring Diagram

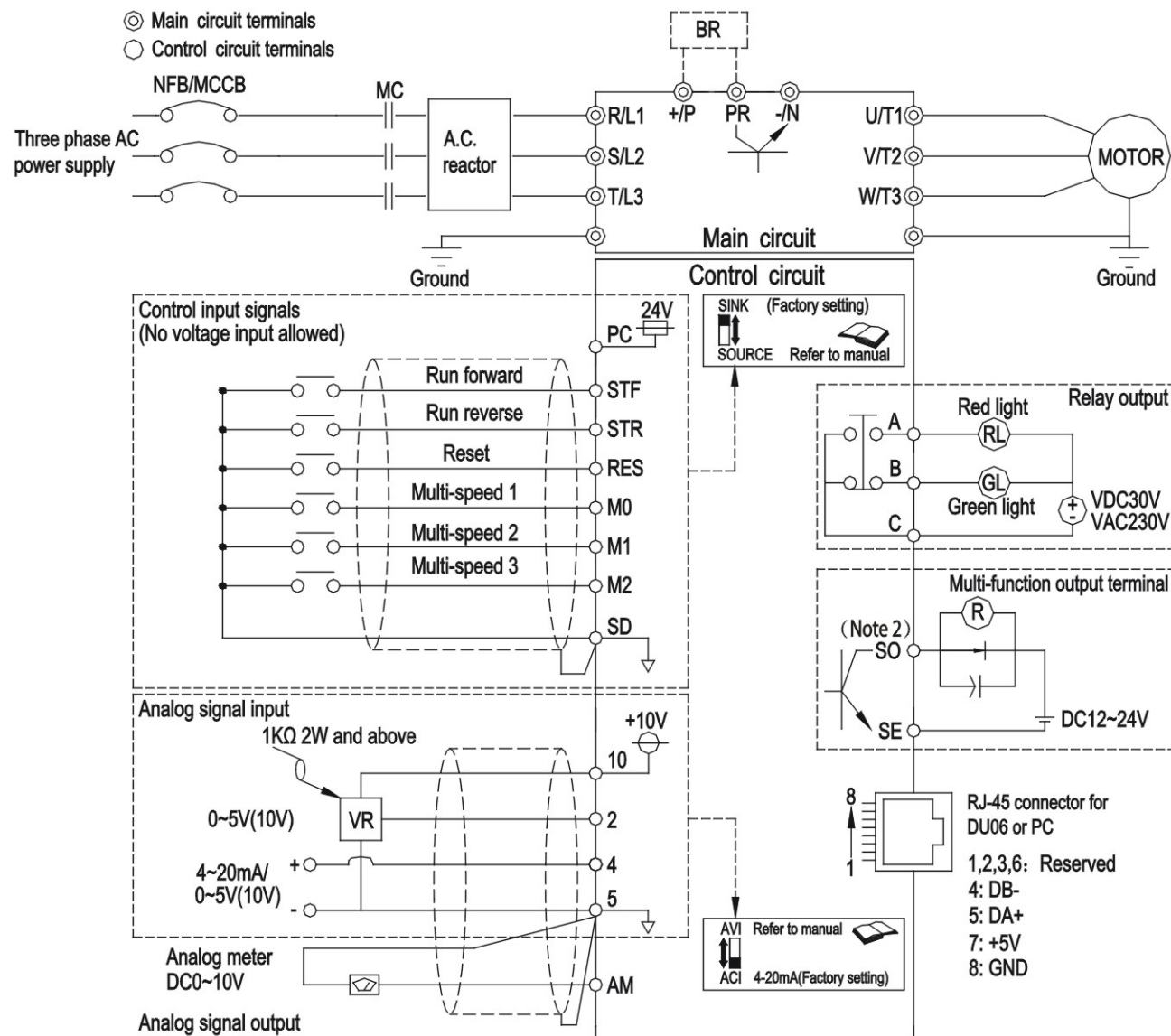

NOTE

1. For the usage of the external thermal relay, please refer to P.80~P.84, P.86 in Chapter 5 (OH) on the manual.
2. Make sure not to short circuit the PC and SD.
3. In the above figure, dotted line area, please refer to 3.5.7 on the manual.
4. The SO terminal can select to FM or 10X function, please refer to P.64, P.74.
5. For single-phase series inverters, there is no T/L3 terminal, and the corresponding wiring(dotted line) doesn't need to be connected.

Dimensions

Frame A

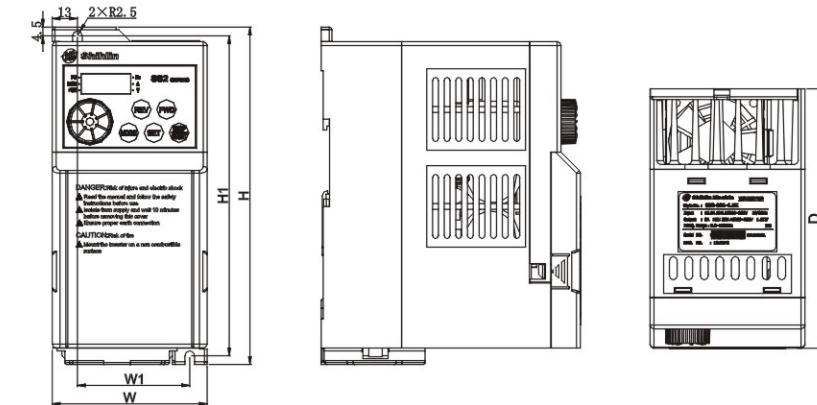

Model	H(mm)	H1(mm)	W(mm)	W1(mm)	D(mm)
SS2-021-0.4K	174	165	80	58	134
SS2-021-0.75K					
SS2-023-0.4K					
SS2-023-0.75K					
SS2-023-1.5K					
SS2-043-0.4K					
SS2-043-0.75K					
SS2-043-1.5K					

Frame B

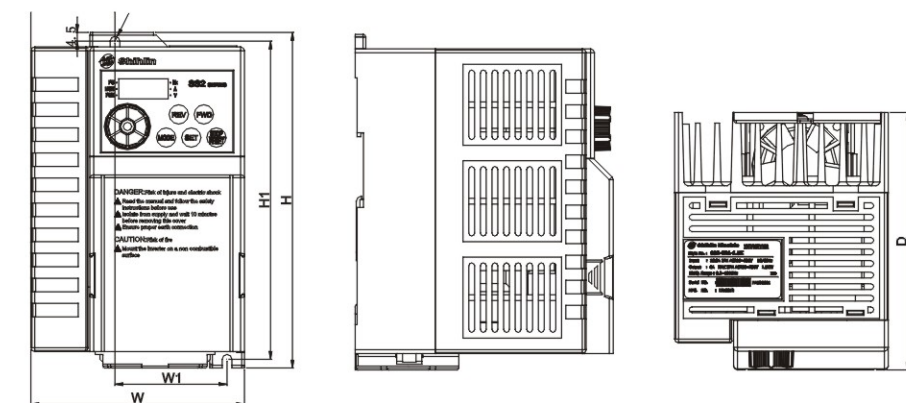

Model	H(mm)	H1(mm)	W(mm)	W1(mm)	D(mm)
SS2-021-1.5K	174	165	110.5	58	134
SS2-021-2.2K					
SS2-023-2.2K					
SS2-023-3.7K					
SS2-043-2.2K					
SS2-043-3.7K					
SS2-043-5.5K					

SE2 Series

High Performance Vector Control AC Drive



Product Range

Model	KW (HP)	0.4 (0.5)	0.75 (1)	1.5 (2)	2.2 (3)	3.7 (5)	5.5 (7.5)	7.5 (10)	11 (15)	
SE2	021	1-phase 220V								
	023	3-phase 220V								
	043	3-phase 440V								

Main Features

- * High starting torque, 150%/1Hz and 200% /3Hz
- * With auto-tuning function
- * Output frequency from 0.2Hz to 1000Hz
- * Speed accuracy: less than 1% with 0~100% load variation
- * High-precision static motor parameter auto-tuning function
- * Excellent performance with load capacity of 200%/1s, 150% 60s
- * Built-in RS-485 communication interface
- * Support MODBUS and Shihlin communication protocol
- * Built-in brake transistor
- * A built in EMC input filter is available
- * Energy saving function realizes power-saving control
- * Constant pressure setting for water pump
- * Support various expansion card: I/O card, RS-485/422 card, 4-20mA power card

Applications



Lathe

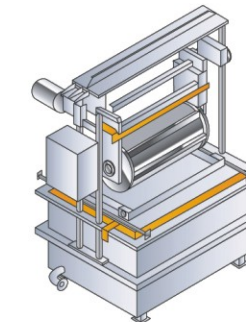

Plating Machine

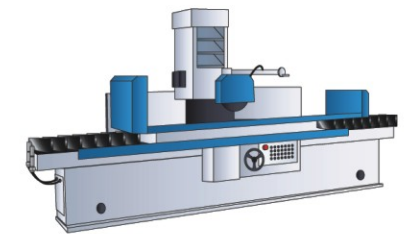

Grinding Machine

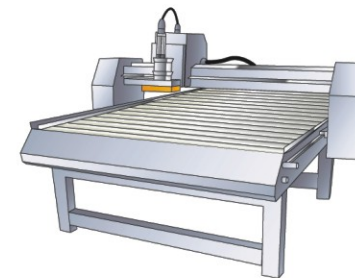

Wood processing Machine



Printing Machine



Chamfer Machine

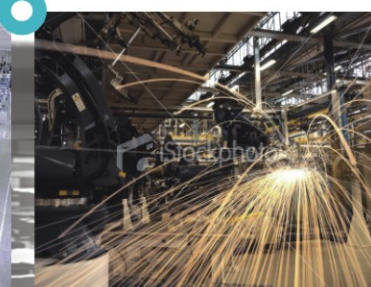

SE2

Product Features

High-performance sensorless vector control technique

- A 32-bit RISC CPU for high-speed computation.
- Starting torque, 150% / 1Hz
- High-precision motor parameter auto-tuning function.
- Speed accuracy is within 1% (0%~100% loading change)
- Speed control ratio is up to 1:100

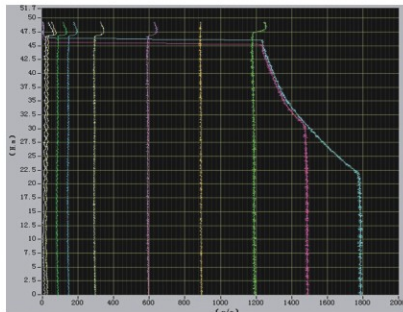

Built-in RS-485 interface

- Additional two communication terminals on the control board.
- Capable of simultaneous connections resulting a HMI, PLC and other devices.

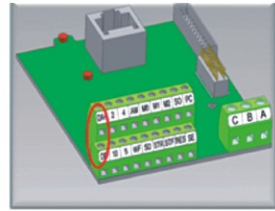

Tracking compensation mechanism

- The enhanced tracking mechanism can detect the rotation speed and direction of motor in idle state, resulting a smooth machine start without jittering.

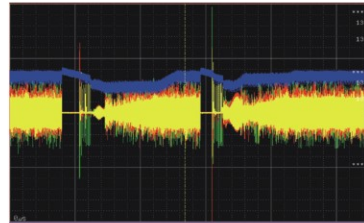

Excellent performance with load capacity of 200% 1s

- For impact load, safe to use (punch/trolley/injector/screw machinery/machine tool, and so on).

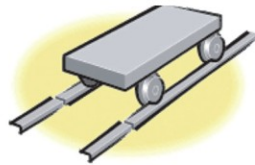

5-point V/F free setting

- It is more adaptable to various complicated load environment, such as multiple working frequencies.

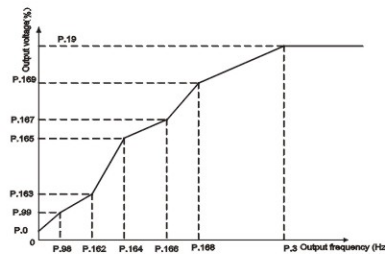

Equipped with Soft-PWM mechanism

- Soft-PWM controls the motor noises, transforming the metal sound into a delightful complex tone.
- It provides low noise operation and reduces interference to external RF, ensuring stable operations of nearby PLC and encoder devices.

Product Features

The range of the output frequency is expanded to 0 – 1,000 Hz

- It is good choice for high-speed motor applications, such as engraving machines, grinders, centrifuges, etc.

Parameter No.	Parameter Name	Setting Range
P.4-P.6	Multiple frequencies	0-1000Hz
P.24-P.27		
P.142-P.149		
P.3/P.47	Base frequency	0-1000Hz
P.18	High-speed upper limit frequency	120-1000Hz
P.38-P.39	The highest frequency of the module	1-1000Hz

Triangular wave mechanism (traverse)

- This is suitable for traversing and winding movements such as textile operations.

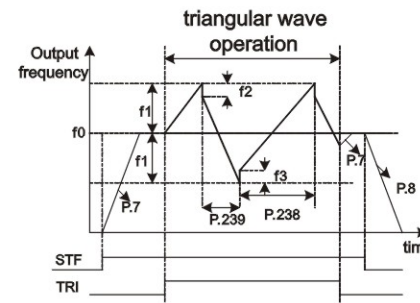

Operating time accumulation and parameters protection

- Time accumulation: the accumulated operating time of the AC drive can be displayed.
- Password protection: It provide 4-digital password to restrict the read and write of parameters, and prevent operative mistakes.

PC client communication software

- This provides remote control of multiple frequency AC drives for parameters setup, copy and monitoring.

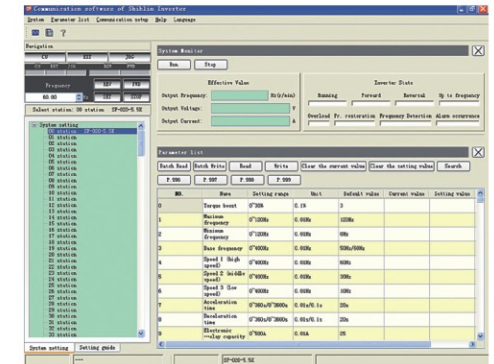

Support various expansion boards.

- SE2-PD01: Profibus communication module
- SE2-DN01: Device-NET communication module
- SE-IB01: 4-20 mA current output expansion board.
- SE-CB01: terminal-type communication expansion board
- SE-EB01: I/O expansion board (Relay output)



Built-in EMC input filter

- There is a built-in EMC input filter design. It qualifies the EN61800-3 specifications and it can reduce electromagnetic interruption effectively.



Electric Specifications

220V Single-phase Series

Model SE2-021-□□□K		0.4K	0.75K	1.5K	2.2K
Applicable Motor Capacity	HP	0.5	1	2	3
	kW	0.4	0.75	1.5	2.2
Output	Rated Output Capacity kVA	1.2	1.9	3.0	4.2
	Rated Output Current A	3.0	5.0	8.0	11.0
	Overload current rating	150% 60 seconds; 200% 1 second (inverse time characteristics)			
	Maximum Output Voltage	3 Phase 200~240V AC			
Power	Rated Power Voltage	single phase 200~240V 50Hz / 60Hz			
	Permitted Power and Voltage Range	single phase 180~264V 50Hz / 60Hz			
	Adjustable Power and Frequency Range	±5%			
	Power supply capacity kVA	1.8	3	4.5	6.4
Cooling Method	Self-cooling	Forced Air cooling			
Weight (Kg)	1.2	1.2	1.9	1.9	

220V Three-phase Series

Model SE2-023-□□□K		0.4K	0.75K	1.5K	2.2K	3.7K	5.5K	7.5K
Applicable Motor Capacity	HP	0.5	1	2	3	5	7.5	10
	kW	0.4	0.75	1.5	2.2	3.7	5.5	7.5
Output	Rated Output Capacity kVA	1.2	1.9	3.0	4.2	6.7	9.2	12.6
	Rated Output Current A	3.0	5.0	8.0	11.0	17.5	24	33
	Overload current rating	150% 60 seconds; 200% 1 second (inverse time characteristics)						
	Maximum Output Voltage	3 Phase 200~240V AC						
Power	Rated Power Voltage	3 Phase 200~240V 50Hz / 60Hz						
	Permitted Power and Voltage Range	3 Phase 170~264V 50Hz / 60Hz						
	Adjustable Power and Frequency Range	±5%						
	Power supply capacity kVA	1.8	3	4.5	6.4	10	13.8	19
Cooling Method	Self-cooling	Forced Air cooling						
Weight (Kg)	1.2	1.2	1.2	1.9	1.9	3.8	3.8	

440V Three-phase Series

Model SE2-043-□□□K		0.4K	0.75K	1.5K	2.2K	3.7K	5.5K	7.5K	11K
Applicable Motor Capacity	HP	0.5	1	2	3	5	7.5	10	15
	kW	0.4	0.75	1.5	2.2	3.7	5.5	7.5	11
Output	Rated Output Capacity kVA	1.2	2.0	3.2	4.6	6.9	9.2	13	18
	Rated Output Current A	1.5	2.6	4.2	6.0	9.0	12	17	23
	Overload current rating	150% 60 Seconds; 200% 1 Second (inverse time characteristics)							
	Maximum Output Voltage	Three-phase 380~480V							
Power	Rated Power Voltage	Three-phase 380~480V 50Hz / 60Hz							
	Permitted Power and Voltage Range	323~506V 50Hz / 60Hz							
	Adjustable Power and Frequency Range	±5%							
	Power supply capacity kVA	1.8	3	4.8	6.9	10.4	13.8	19.5	27
Cooling Method	Self-cooling	Forced Air cooling							
Weight (Kg)	1.2	1.2	1.2	1.9	1.9	3.8	3.8	3.8	

Common Specifications

Control method	SVPWM control, V/F control, vector control, sensorless vector control.		
Output frequency range	0.2~1000Hz (The starting frequency setting range is 0~600Hz). Please refer to P.187 in Chapter 4.		
Resolution for setting frequency	Digital setting	When P.187=0, if the frequency set value is below 100Hz, the resolution will be 0.01Hz. If the frequency set value is above 100Hz, the resolution will be 0.1Hz. When P.187=1, the resolution of frequency will be 0.1Hz.	
	Analog setting	When setting DC 0~5V signals, the resolution will be 1/500; When setting DC 0~10V or 4~20mA signals, the resolution will be 1/1000.	
Output frequency accuracy	0.01Hz		
Voltage / frequency output characteristics	Base frequency voltage (P.19), base frequency (P.3) can be arbitrarily set in available range. Constant torque model, applicable load model can be selected (P.14).		
Start torque	150% (1Hz); When the sensorless vector control is started.		
Torque boost	The torque boost setting range is 0~30% (P.0), auto boost, slip compensation.		
Acceleration/deceleration curve characteristics	The resolution (0.01s/0.1s) of acceleration/deceleration time (P.7, P.8) is switched by P.21. The setting range has 0~360s or 0~3600s for selection. And different acceleration/deceleration curve model can be selected by P.29.		
DC braking	The DC braking action frequency is 0~120Hz (P.10); the DC braking time is 0~60 Seconds (P.11); and the DC braking voltage is 0~30% (P.12). Linear braking and Idling braking selection (P.71).		
Stall current protection	The stalling protection level can be set to 0~400% (P.22).		
Target frequency setting	Operation panel setting; DC 0~5V signal setting, DC 0~10V signal setting and DC 4~20mA signal setting, 2 voltage input or one voltage and one current input can be selected; Multi-speed stage levels setting; Communication setting.		
PID control	Please refer to P.170~P.183 and P.223 ~ P.225 in Chapter 4.		
Multi-function control terminals	Motor starting (STF, STR), the second function (RT), the 16-speed operation (RL, RM, RH, REX), external thermal relay (OH), reset (RES) , etc. (they can be set by the user with P.80~P.84, P.86)		
Multi-function output terminals	Multi-function output terminals (SO, SE)	P.40 Inverter running (RUN), output frequency detection (FU), Up to output frequency (SU), overload alarm (OL), zero current detection (OMD), zero current detection alarm (ALARM), Section detection (PO1), Periodical detection (PO2), and Pause detection (Po3), Inverter output (BP), Commercial power-supply output (GP), ready signal output (RY).	
	Multi-function output relay	P.85	
	Multi function analogy output	Multi-function DC (0~10V)(AM) Output: output frequency, output current (P.54).	
Operation panel	Running status monitoring	Output frequency monitoring, output current monitoring, and output voltage monitoring.	
	HELP mode	Alarm history monitoring, alarm history clear, all parameters clear, and firmware version read.	
	LED indication lamp(6)	Run indication lamp, frequency monitoring indication lamp, voltage monitoring indication lamp, current monitoring indication lamp, mode switching indication lamp, and PU/external terminals control indication lamp.	
Communication function	RS485	Build in RS485 communication.	
	Communication expansion board	Optional accessories: Terminal type, RJ11, RJ-45, Profibus or Device Net communication expansion board (Note 2,3,4).	
Protection mechanism / Alarm function	Output short circuit protection, Over-current protection, P-N over-voltage protection, under-voltage protection, motor over heat protection (P.9), IGBT module over heat protection, communication abnormality protection, etc.		
Environmental condition	Ambient temperature	-10 ~ +50°C (non-freezing)	
	Ambient humidity	Below 90%Rh (non-condensing)	
	Storage temperature	-20 ~ +65°C	
	Surrounding environment	In room, no corrosive gas, no flammable gas, no flammable dust	
	Altitude and vibration	Altitude: below 1000 meters, Vibration: below 5.9m/s ² (0.6G).	
Certification	Meet the requirements of CE certification standards (the -DL type).		

- Note: 1. If several multi-function output relays are needed, you can choose the I/O expansion board, on which there are 2 multi-function output relays. For detailed instruction, please refer to appendix 5.
 2. Communications expansion board option details, please refer to Appendix 5.
 3. Profibus is the registered trademark of Profibus international.
 4. Device Net is the registered trademark of ODVA (Open Device Vendor Association).

Wiring Diagram

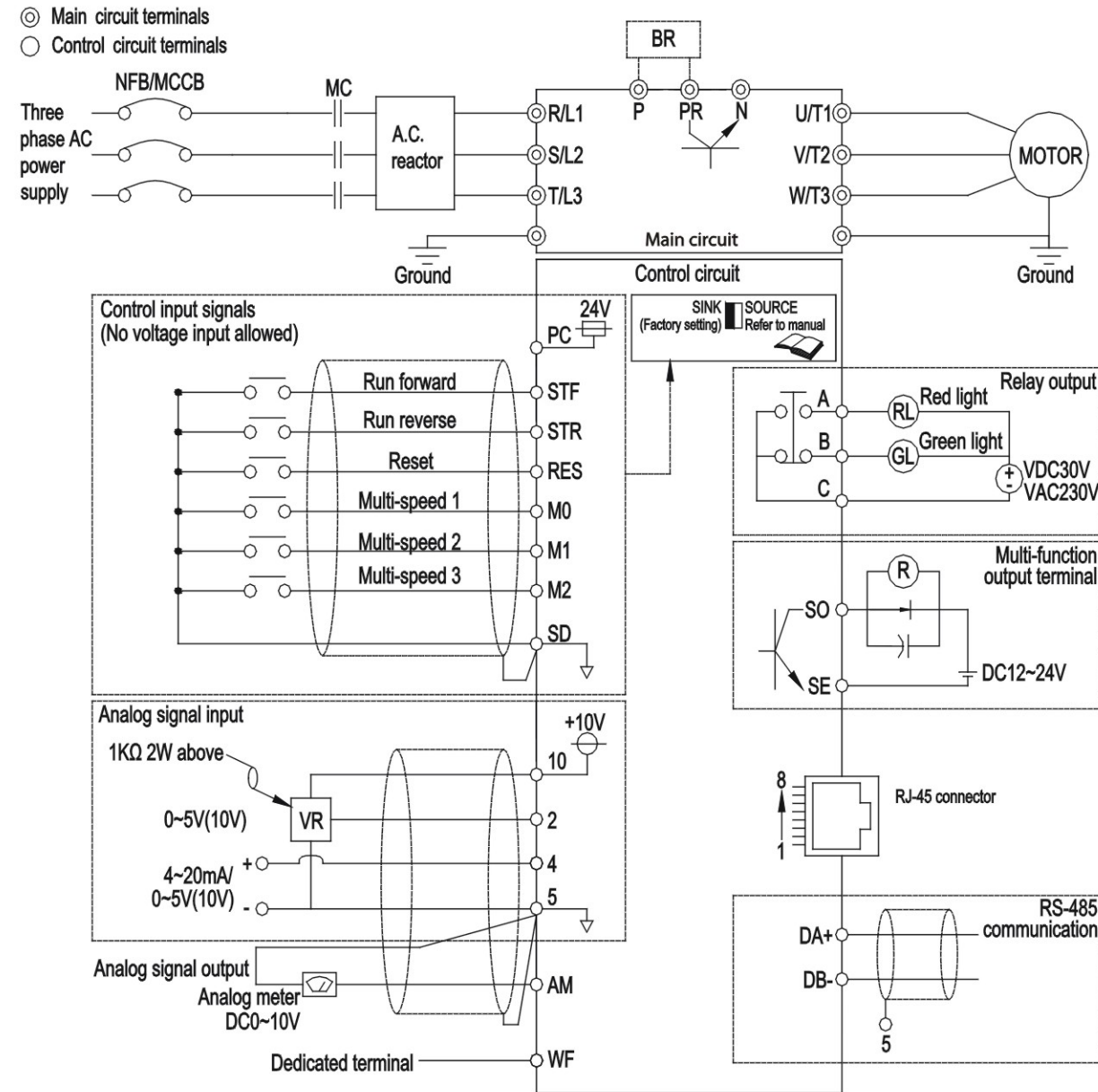

NOTE

1. For the usage of external thermal relay, please refer to P.80~P.84, P.86 (OH) in Chapter 4.
2. Make sure do not to short PC and SD.
3. In the above figure, Dotted line metal, please refer to 2.5.7 on the manual.
4. The SE2-TYPE inverter have internal RS485 communication, and can also uses pluggable communications expansion boards CB01, CB02, CB03, PD01, DN01; For detailed instructions, please refer to the manual.

Dimensions

Frame

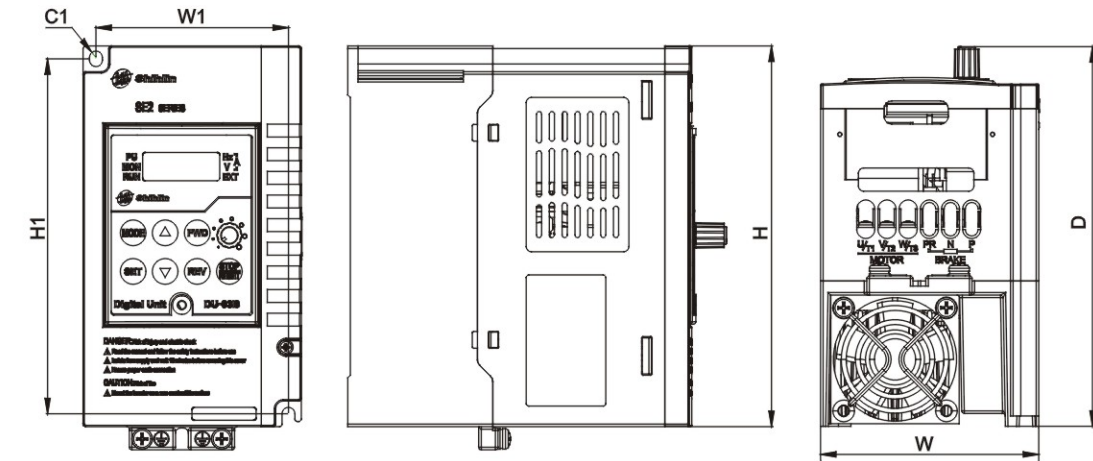

Model	H(mm)	W(mm)	D(mm)	W1(mm)	H1(mm)	C1(mm)
SE2-021-0.4K	148	85	148	75	138	Φ 5
SE2-021-0.75K	148	85	148	75	138	Φ 5
SE2-021-1.5K	186	100	157	90	176	Φ 5
SE2-021-2.2K	186	100	157	90	176	Φ 5
SE2-023-0.4K	148	85	148	75	138	Φ 5
SE2-023-0.75K	148	85	148	75	138	Φ 5
SE2-023-1.5K	148	85	148	75	138	Φ 5
SE2-023-2.2K	186	100	157	90	176	Φ 5
SE2-023-3.7K	186	100	157	90	176	Φ 5
SE2-023-5.5K	266	141	201.5	126	244	Φ 6
SE2-023-7.5K	266	141	201.5	126	244	Φ 6
SE2-043-0.4K	148	85	148	75	138	Φ 5
SE2-043-0.75K	148	85	148	75	138	Φ 5
SE2-043-1.5K	148	85	148	75	138	Φ 5
SE2-043-2.2K	186	100	157	90	176	Φ 5
SE2-043-3.7K	186	100	157	90	176	Φ 5
SE2-043-5.5K	266	141	201.5	126	244	Φ 6
SE2-043-7.5K	266	141	201.5	126	244	Φ 6
SE2-043-11K	266	141	201.5	126	244	Φ 6

SF-G Series

Dual-load, High Performance
Vector Control AC Drive



Product Range

Model	KW (HP)	2.2 (3)	3.7 (5)	5.5 (7.5)	7.5 (10)	11 (15)	15 (20)	18.5 (25)	22 (30)	30 (40)	37 (50)	45 (60)	55 (75)	75 (100)	90 (120)	110 (150)	132 (175)	160 (215)	185 (250)	220 (300)	250 (335)	280 (375)	315 (420)	355 (475)
SF-G	020-G	3-phase 220V	120%, 60s →	150%, 60s →	[Availability grid with diagonal lines]																			
	040-G	3-phase 440V	120%, 60s →	150%, 60s →	[Availability grid with diagonal lines]																			

Main Features

- * Dual specifications with HD: 150% 60s / LD: 120% 60s
- * V/F control, general purpose magnetic flux vector control, SVC sensor-less vector control, FOC+PG closed loop vector control, high torque output at low speed, and the best power saving control mode.
- * Increased load capacity to 200% / s
- * Embedded regeneration brake transistor(22kW or below)
- * Strengthened PID function, Multi-channel control function for fan and pump
- * RS-485 interface, selection between Shihlin protocol/standard Modbus protocol
- * Strengthened speed tracking compensation capability
- * Soft PWM function
- * Multiple function pulse output
- * Remote control panel through RJ45
- * Support various expansion boards : injection molding machine specific expansion boards, Multi-channel control function for fan and pump

Application

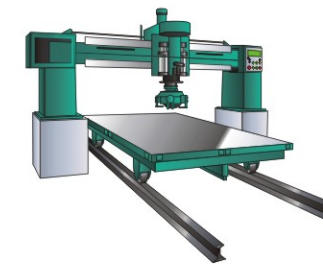

Polishing Machine

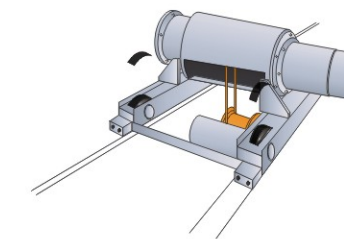

Crane

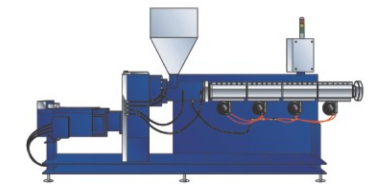

Extrusion Machine

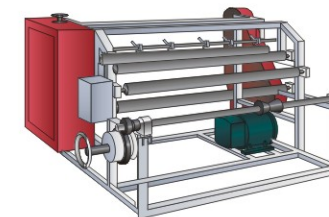

Textile Equipment



CNC tooling Machine



Solder Equipment



SF-G

Product Features

Dual-load specifications

- Light load 120% 60s / heavy load (-G) 150% 60s.
- The default capacity is light load for air conditioners, pumps, air compressors, conveyors and other machines using light loads.
- The parameters can be adjusted to heavy load by inner parameter setting for punches, cranes, trolleys, screw machinery, machine tools, and injection devices (by PM01 injector expansion card).

High-performance vector control technology

- A 32-bit RISC CPU for high-speed computation.
- SVC sensorless vector control with high starting torque of 1Hz150%, and FOC+PG closed loop vector control of 0Hz 150%.
- Speed accuracy: less than 1% with 0-100% load variation.
- An exclusive pioneer of high-precision motor parameter auto-tuning function.

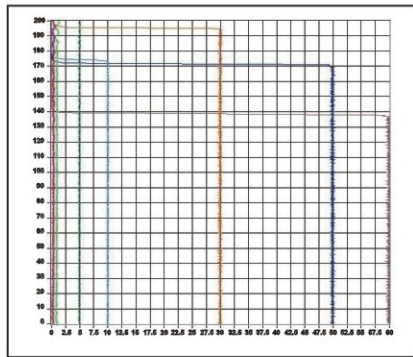

Tracking compensation mechanism

- The enhanced tracking mechanism can detect the rotation speed and direction of motor in idle state, resulting a smooth machine start without jittering.

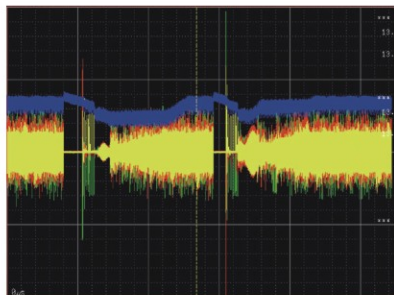

Built-in brake transistor (under 22kw)

- Built-in brake transistor (under 22kw).
- Its connection with the brake resistor to improve the braking torque capability.

Equipped with Soft-PWM mechanism

- Soft-PWM controls the motor noises, transforming the metal sound into a delightful complex tone.
- It provides low noise operation and reduces interference to external RF, ensuring stable operations of nearby PLC and encoder devices.

- f0 : Setting value of frequency
- f1 : Generated amplitude for setting frequency ($f_0 \times P.235$)
- f2 : Compensation from acceleration to deceleration ($f_1 \times P.236$)
- f3 : Compensation from deceleration to acceleration ($f_1 \times P.237$)

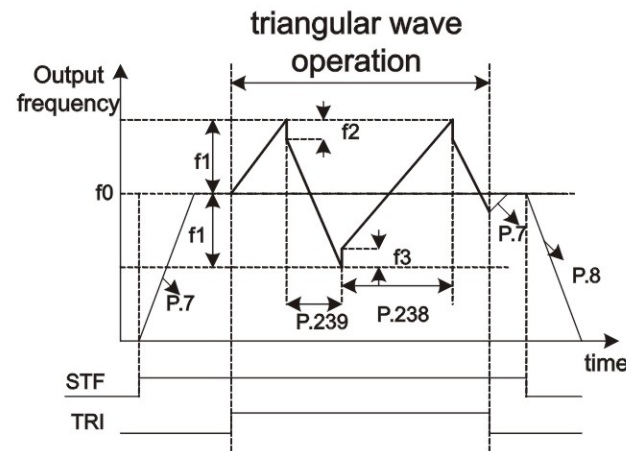

Product Features

Equipped with grid power frequency switching mechanism

- It provides automatic switch between the grid power and frequency conversion.
- If the motor is running at rated frequency, using grid power frequency has a much better efficiency.
- In order to prevent the motor from stopping for a long time during the maintenance of AC drive, it is recommended AC drive to have bypass loop.

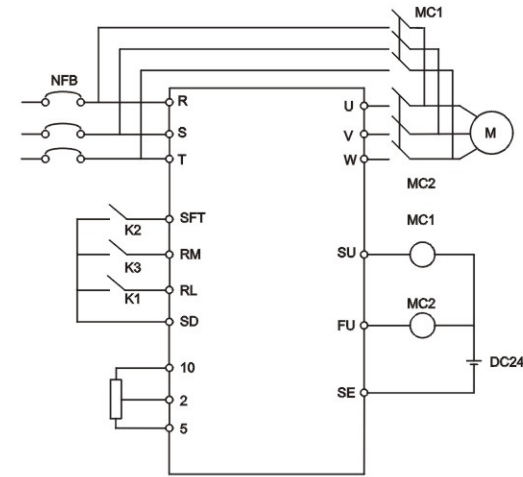

Operating time accumulation and parameters protection

- Time accumulation: the accumulated operating time of the AC drive can be displayed.
- Password protection: It provide 4-digital password to restrict the read and write of parameters, and prevent operative mistakes.

Built-in RS-485 interface

- Support for MODBUS and Shihlin protocol.
- Capable of simultaneous connections to HMI, PLC and other devices.

PC communication software

- This provides remote control of multiple frequency AC drive for parameters setup, copy and monitoring.

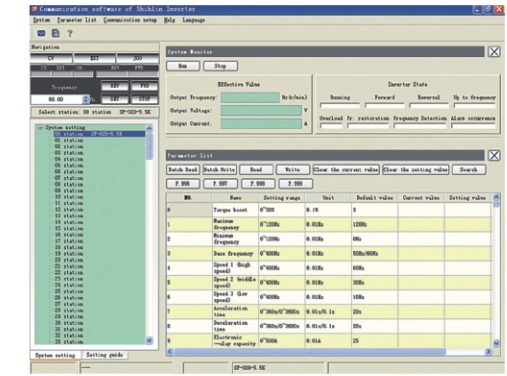

5-point V/F free setting

- It is more adaptable to various complicated load environment, such as multiple working frequencies.

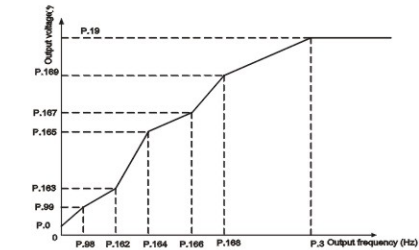

Containing with 12 sets of abnormality alarm records

- The 12 sets of alarm records can be easily accessed.
- The system can record abnormal side power input(phase failure), short circuit of side output, over current, over voltage, module overheating, motor overheating, fan abnormalities, communication abnormalities, and so on.

Excellent performance with load capacity of 200% 1 s (-G)

- For impact load, safe to use (punch/trolley/injector/ screw machinery/machine tool, and so on).

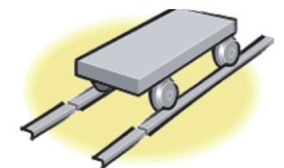

Electric Specifications

220V Series Three-phase

Model SF-020- □□□ / □□□ K-G		5.5	7.5/5.5	11/7.5	15/11	18.5/15
Applicable motor capacity	HP	7.5	10/7.5	15/10	20/15	25/20
	kw	5.5	7.5/5.5	11/7.5	15/11	18.5/15
Output	Rated output capacity kVA	9.5	12.5/9.5	18.3/12.5	24.7/18.3	28.6/24.7
	Rated output current A	25	33/25	49/33	65/49	75/65
	Overload current rating	120% 60 seconds / 150% 60 seconds (inverse time characteristics)				
Power supply	Maximum output voltage	Three-phase 200 - 240V				
	Rated power voltage	Three-phase 200 - 240V 50Hz / 60Hz				
	Power voltage permissible fluctuation	Three-phase 180 - 264V 50Hz / 60Hz				
	Power frequency permissible fluctuation	±5%				
	Power source capacity kVA	12	17/12	20/17	28/20	34/28
	Cooling method	Forced air cooling				
weight (kg)	5.6	5.6	7.0	8.3	9.0	

Model SF-020- □□□ / □□□ K-G		22/18.5	30/22	37/30	45/37	55/45
Applicable motor capacity	HP	30/25	40/30	50/40	60/50	75/60
	kw	22/18.5	30/22	37/30	45/37	55/45
Output	Rated output capacity kVA	34.3/28.6	45.7/34.3	55/45.7	65/55	81/65
	Rated output current A	90/75	120/90	145/120	170/145	212/170
	Overload current rating	120% 60 seconds 150% 60 seconds (inverse time characteristics)				
Power supply	Maximum output voltage	Three-phase 200 - 240V				
	Rated power voltage	Three-phase 200 - 240V 50Hz / 60Hz				
	Power voltage permissible fluctuation	Three-phase 180 - 264V 50Hz / 60Hz				
	Power frequency permissible fluctuation	±5%				
	Power source capacity kVA	41/34	52/41	65/52	79/65	99/79
	Cooling method	Forced air cooling				
weight (kg)	20	21	37	37	67	

440V Series Three-phase

Model SF-040- □□□ / □□□ K-G		5.5	7.5/5.5	11/7.5	15/11	18.5/15	22/18.5	30/22	37/30	
Applicable motor capacity	HP	7.5	10/7.5	15/10	20/15	25/20	30/25	40/30	50/40	
	kw	5.5	7.5/5.5	11/7.5	15/11	18.5/15	22/18.5	30/22	37/30	
Output	Rated output capacity kVA	10	14/10	18/14	25/18	29/25	34/29	46/34	56/46	
	Rated output current A	13	18/13	24/18	32/24	38/32	45/38	60/45	73/60	
	Overload current rating	120% 60 seconds 150% 60 seconds (inverse time characteristics)								
Power supply	Maximum output voltage	Three-phase 380 - 480V								
	Rated power voltage	Three-phase 380 - 480V 50Hz / 60Hz								
	Power voltage permissible fluctuation	Three-phase 342 - 528V 50Hz / 60Hz								
	Power frequency permissible fluctuation	±5%								
	Power source capacity kVA	11.5	16/11.5	20/16	27/20	32/27	41/32	52/41	65/52	
	Cooling method	Forced air cooling								
weight (kg)	5.6	5.6	5.6	5.6	8.3	8.3	25	25		

Model SF-040- □□□ / □□□ K-G		45/37	55/45	75/55	90/75	110/90	132/110	160/132	
Applicable motor capacity	HP	60/50	75/60	100/75	120/100	150/120	175/150	215/175	
	kw	45/37	55/45	75/55	90/75	110/90	132/110	160/132	
Output	Rated output capacity kVA	69/56	84/69	114/84	137/114	168/137	198/168	236/198	
	Rated output current A	91/73	110/91	150/110	180/150	220/180	260/220	310/260	
	Overload current rating	120% 60 seconds 150% 60 seconds (inverse time characteristics)							
Power supply	Maximum output voltage	Three-phase 380 - 480V							
	Rated power voltage	Three-phase 380 - 480V 50Hz / 60Hz							
	Power voltage permissible fluctuation	Three-phase 342 - 528V 50Hz / 60Hz							
	Power frequency permissible fluctuation	±5%							
	Power source capacity kVA	79/65	100/79	110/100	137/110	165/137	198/165	247/198	
	Cooling method	Forced air cooling							
weight (kg)	25	37	37	37	67	67	67		

Model SF-040- □□□ / □□□ K-G		185/160	220/185	250/220	280/250	315/280	355/315	
Applicable motor capacity	HP	250/215	300/250	335/300	375/335	420/375	475/420	
	kw	185/160	220/185	250/220	280/250	315/280	355/315	
Output	Rated output capacity kVA	295/236	367/295	402/367	438/402	491/438	544/491	
	Rated output current A	340/310	425/340	480/425	530/480	620/530	683/620	
	Overload current rating	120% 60 seconds / 150% 60 seconds (inverse time characteristics)						
Power supply	Maximum output voltage	Three-phase 380 ~ 480V						
	Rated power voltage	Three-phase 380 ~ 480V 50Hz / 60Hz						
	Power voltage permissible fluctuation	Three-phase 342 ~ 528V 50Hz / 60Hz						
	Power frequency permissible fluctuation	±5%						
	Power source capacity kVA	295/247	367/295	402/367	438/402	491/438	544/491	
	Cooling method	Forced air cooling						
weight (kg)	84	90	94	94	123	123		

Common Specifications

Control method	SVPWM control , V/F control, close-loop V/F control (VF+PG), general flux vector control, sensorless vector control (SVC), close-loop vector control (FOC+PG)			
Output frequency range	0.2-400Hz (The starting frequency setting range is 0-60Hz)			
Resolution for setting frequency	Digital setting	If the frequency set value is below 100Hz, the resolution will be 0.01 Hz; If the frequency set value is above 100Hz, the resolution will be 0.1 Hz		
	Analog setting	When setting DC 0-5V signals, the resolution will be 1/500 ; When setting DC 0-10V or 4-20mA signals, the resolution will be 1/1000		
Output frequency accuracy	Digital setting	Maximum target frequency : ±0.01 %		
	Analog setting	Maximum target frequency : ±0.5%		
Voltage I frequency output characteristics	Base voltage (P.19), base frequency (P.3) can be arbitrarily set ; Constant torque model and applicable load model can be selected (P.14)			
Start torque	150% 1H z : When the sensorless vector control is started			
Torque boost	The torque boost setting range is 0-30% (P.0), auto boost, slip compensation			
Acceleration / deceleration curve characteristics	The resolution (0.01s/0.1s) of acceleration/deceleration time (P.7, P.8) is switched by P.21. The setting range has 0~360s or 0~3600s for selection. And different acceleration/deceleration curve model can be selected by P.29.			
DC braking	The DC braking action frequency is 0-120Hz (P.10); the DC braking time is 0- 60s (P.11) The DC braking voltage is 0-30% (P.12).Linear braking and idling braking selection (P.71)			
Stall current protection	The stalling protection level can be set to 0-400% (P.22)			
Target frequency setting	Operation panel setting; DC 0-5V signal, DC 0-10V signal, DC 4-20 mA signal, multiple speed stage level setting, communication setting			
PID control	Please refer to manual P.170-P.182 in Chapter 5			
Multi-function control terminals	Motor starting (STF, STR), the second function (RT), 16-speed operation (RH, RM, RL, REX), external thermal relay (OH), reset (RES),etc.(they can be set by the user with P.80~P.84, P.86 and P.126~P.128).			
Output terminal	Multi-function output terminals	SU, SE	P.40	Inverter running (RUN), output frequency detection (FU), Up to output frequency (SU), overload alarm (OL), zero current detection (OMD), alarm (ALARM), section detection (PO1), periodical detection (PO2), and pause detection (PO3).
		RUN, SE	P.129	
	FU/10X, SE	P.130		
	Multi-function output relay	A, B, C	P.85	
Operation Panel	Analog output	AM,5	Multi-function DC (0-10V) output: output frequency, current (P.54)	
	Pulse output	FM,SD	Output the pulse of 0-2300Hz	
Operation Panel	Operation monitoring	Output frequency monitoring, output current monitoring, and output voltage monitoring, abnormality record (Maximum 12 sets)		
	LED indication lamp(8)	Forward rotation indication lamp, reverse rotation indication lamp, frequency monitoring indication lamp, voltage monitoring indication lamp, current monitoring indication lamp, mode switching indication lamp, PU terminals control indication lamp, and external terminals control indication lamp		
Communication function	RS-485 communication, can select Shihlin/Modbus protocol communication protocol			
Protection mechanism / alarm function	Output short circuit protection, Over-current protection, (+P)/(-N) over-voltage protection under-voltage protection, motor over-heat protection (P.9), IGBT module over-heat protection, communication abnormality protection, etc			
Environmental Condition	Ambient temperature	-10~+40°C (non-freezing)		
	Ambient humidity	Below 90%Rh (non-condensing)		
	Storage temperature	-20 ~ +65°C		
	Surrounding environmen	Indoor, no corrosive gas, no flammable gas, no flammable powder		
	Altitude and vibration	Altitude: below 1000 meters, Vibration: below 5.9m/s ² (0.6G).		
Environmental Condition	Grade of protection	IP20		
	The degree of environmental pollution	2		
	Class of protection	Class I		
International certification	 (Except the type of-GS)			

Wiring Diagram

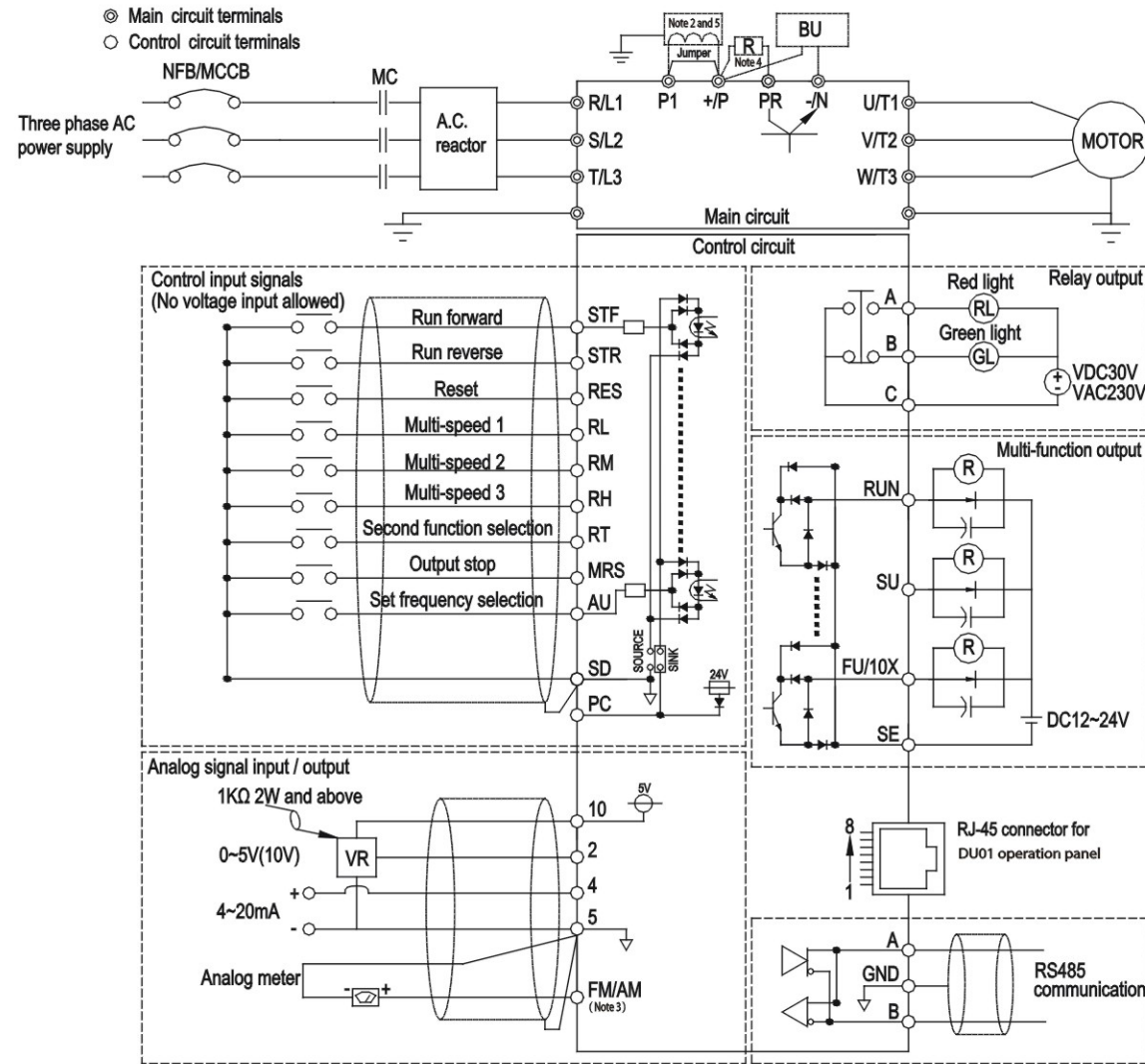

NOTE

1. Please refer to P.80~P.84, P.86 and P.126~P.128 (OH) of Chapter 5 for the applications of external thermal overload relay.
2. Make sure not to short PC and SD.
3. The DC reactor between +/P and P1 is optional. Please short +/P and P1 when DC reactor is not used.
4. When selecting FM function for the FM/AM output terminal, the reference ground is SD. For more details, please refer to P.64.
5. The brake resistor connection approach between +/P and PR is for frames A and B only. For connecting the brake unit of frame C, D, E, F to between +/P and -/N, please refer to terminal arrangement in 3.4.5
6. Inverters corresponding to frame C, E, F have build-in DC reactors, you can also refer to DC reactor specification on the manual before adding DC reactors in addition. (When adding DC reactors, please remove the short circuit piece between P1 and +/P)

Dimensions

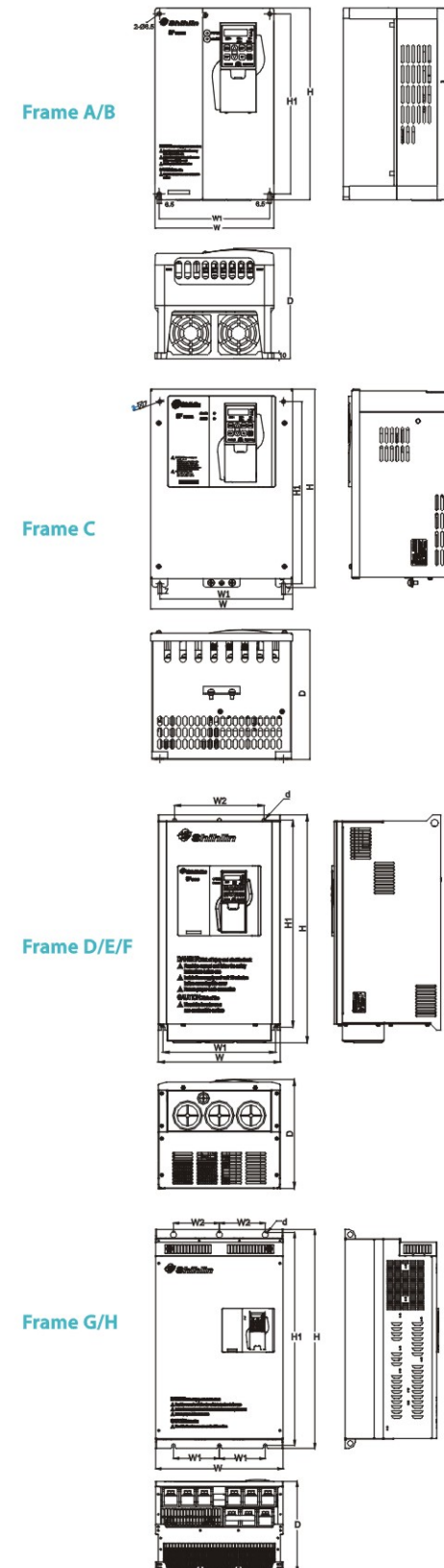

Frame A/B

Model	Frame	H (mm)	H1 (mm)	W (mm)	W1 (mm)	D (mm)
SF-020-5.5K	A	323	303	200	186	186
SF-020-7.5K/5.5K-G						
SF-040-5.5K						
SF-040-7.5K/5.5K-G						
SF-040-11K/7.5K-G						
SF-040-15K/11K-G	B	350	330	230	214	195
SF-020-11K/7.5K-G						
SF-020-15K-11K-G						
SF-020-18.5K/15K-G						
SF-040-18.5K/15K-G						
SF-040-22K-18.5K-G						
SF-040-30K/22K-GS						

Frame C

Model	Frame	H (mm)	H1 (mm)	W (mm)	W1 (mm)	D (mm)
SF-020-22K-18.5K-G	C	379	348	271	236	248
SF-020-30K/22K-G						

Frame D/E/F

Model	Frame	H (mm)	H1 (mm)	W (mm)	W1 (mm)	W2 (mm)	D (mm)	d (mm)
SF-040-30K/22K-G	D	561	510	300	277	220	270	9
SF-040-37K/30K-G								
SF-040-45K-37K-G								
SF-020-37K/30K-G	E	595	566	370	336	336	286	13
SF-020-45K-37K-G								
SF-040-55K/45K-G								
SF-040-75K/55K-G								
SF-040-90K/75K-G	F	850	821	425	381	381	286	13
SF-020-55K/45K-G								
SF-040-110K/90K-G								
SF-040-132K/110K-G								
SF040-160K/132K-G								

Frame G/H

Model	Frame	H (mm)	H1 (mm)	W (mm)	W1 (mm)	W2 (mm)	D (mm)	d (mm)
SF-040-185K/160K-G	G	870	850	500	180	180	360	13
SF-040-220K/185K-G								
SF-040-250K/220K-G								
SF-040-280K/250K-G	H	1000	980	600	230	230	400	13
SF-040-315K/280K-G								
SF-040-355K/315K-G								

SA3/SE3 Series

PD301
Profibus communication expansion board



DN301
DeviceNet communication expansion board

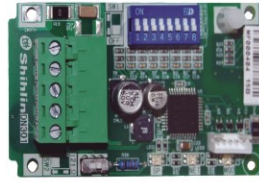

CP301
CANopen communication expansion board



EP301
Ethernet communication expansion board



EB362R
I/O expansion board

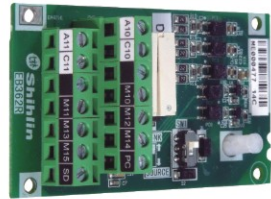

EB308R
I/O expansion board

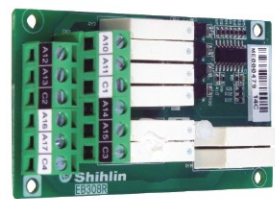

PG301C
Speed feedback board (supports open collector type output)



PG301L
Speed feedback board (supports differential type output)

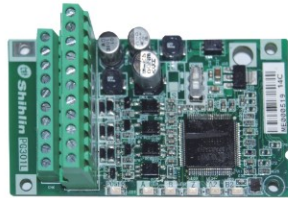

PG302L
Speed feedback board (supports Resolver signal)



EC301
EtherCAT communication expansion board



Select card rack (SE3 special)
Cooperate with SE3 series to select expansion card



*Expected launch before 2018/Q1

Flange mounting kit

Frame A
FMK301

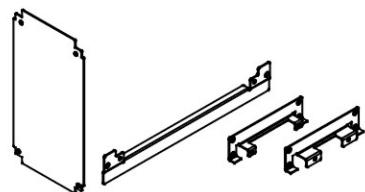

Frame B
FMK302

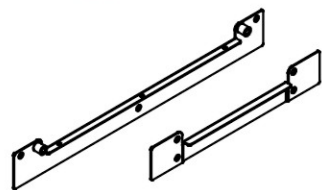

Frame C
FMK303

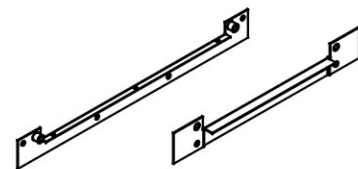

SA3 Series

Floor mounting kit
CTK301

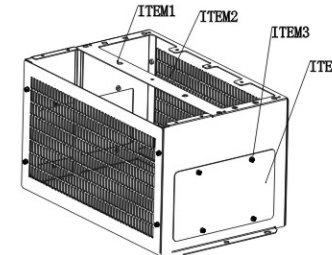

Installation package
SMK301 (PU301, PU301C)

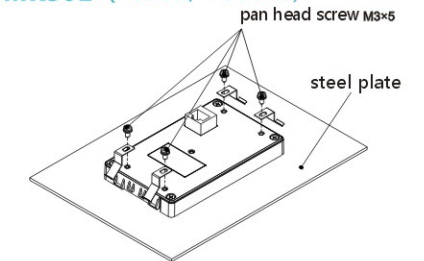

Conduit box kit

Frame D
D:WBK301

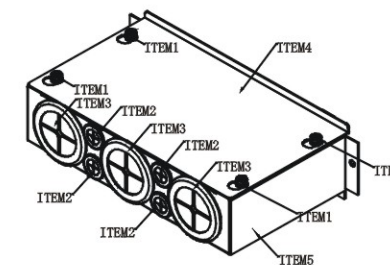

Frame E/F
E:WBK302
F:WBK303

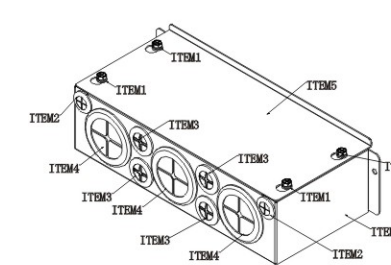

Frame G/H
G:WBK304
H:WBK305

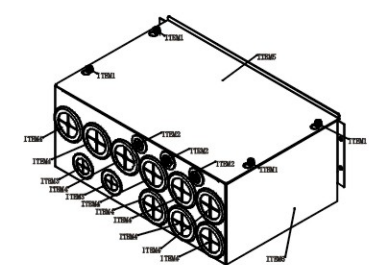

SE2 Series

SE2-PD01
Profibus communication expansion board

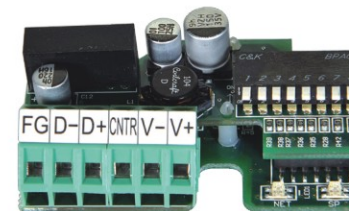

SE2-DN01
Device-Net communication expansion board

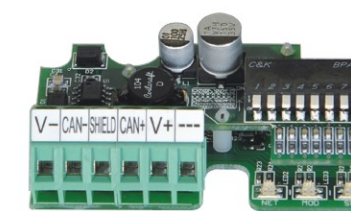

SE-EB01
I/O expansion board

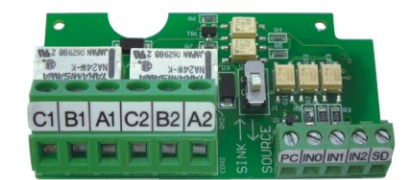

SE-IB01
4-20mA current expansion board

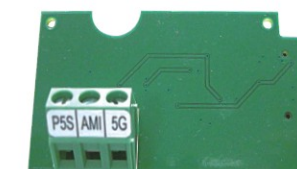

SF-G Series

PG01
PG01 expansion board



PM01
Injection molding machine specific expansion board

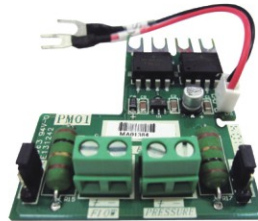

WS01
Fan and water pump Multi-channel control board

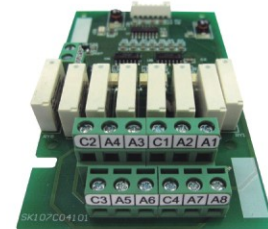

Common

Transmission Cable

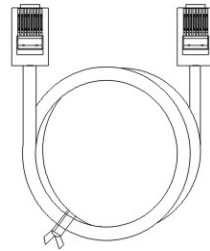

CBL1R5/03/05GT

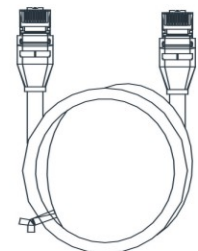

CBL1R5/03/05/10GTN2 (SA3&SC3)

USB01

RS485 to USB communication converter

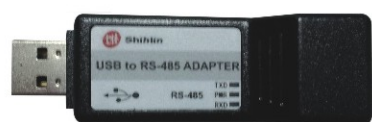

AC/DC Reactor



Regenerative resistor



Keypad

DU01

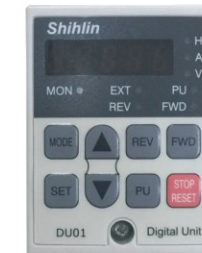

DU03B



DU03C-S



DU05



DU06



DU07



DU08S



DU10



PU301C



PU301



PU302



DU09S



NO.	Type	Controller			
		PU301	PU301C	DU06	DU08S
1	SA3	PU301	PU301C	\	\
2	SE3	PU301	PU302	\	\
3	SC3	PU301	DU06	DU08S	DU10
4	SS2	DU06	DU08S	DU10	\
5	SE2	DU03B	DU03C-S	DU05	DU07
6	SF-G	DU01	DU09S	\	\

Braking Unit (BKU)

Product Model

BKU	- 040	- 45K	- XY
Series category	Voltage level	Capacity	Others
BKU series	-040 : 400V -020 : 200V	37kW 45kW 110kW 160kW	None : General model -xy : Customer motor or dedicated motor or region difference



Features

External sturdy and durable, modular design with fast heat dissipation, single/multiple unit.
Convenient to connect wiring, matching inverter made by all brands with good compatibility.

Appearance and Dimensions

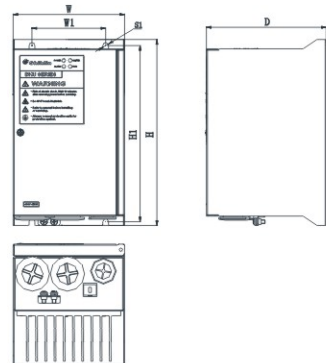

Unit:mm

Model	W	W1	H	H1	D	S1
BKU-020-37K	121	80	200	189.5	130	6.4
BKU-040-45K						
BKU-020-110K	233.5	193.5	343	329	190	6.4
BKU-040-160K						

Braking Resistors & Braking Units Selection

Voltage	Motor	Braking Resistor specifications	Braking Unit	
			Model	Quantity
200V	22K	10800W 6.8Ω	BKU-020-37K	1
	30K	13500W 5Ω	BKU-020-37K	1
	37K	21600W 4Ω	BKU-020-37K	1
	45K	21600W 3.4Ω	BKU-020-37K	2
	55K	27000W 2.5Ω	BKU-020-37K	2
	75K	19200W 2Ω	BKU-020-37K	2
	90KW	25000W 2R	BKU-020-110K	1
400V	110KW	24000W 1.6R	BKU-020-110K	1
	37KW	21600W 16Ω	BKU-040-45K	1
	45KW	21600W 13.6Ω	BKU-040-45K	1
	55KW	27000W 10Ω	BKU-040-45K	2
	75KW	43200W 6.8Ω	BKU-040-45K	2
	90KW	43200W 6.8Ω	BKU-040-45K	2
	110KW	40500W 5Ω	BKU-040-45K	3
	132KW	54000W 4.4Ω	BKU-040-45K	3
	160KW	38400W 4Ω	BKU-040-160K	1
	185KW	38400W 3.4Ω	BKU-040-160K	2
	220KW	57600W 2.7Ω	BKU-040-160K	2
	250KW	48000W 2.5Ω	BKU-040-160K	2
	280KW	67200W 2.3Ω	BKU-040-160K	2
	315KW	67200W 1.9Ω	BKU-040-160K	2
	355KW	72000W 1.7Ω	BKU-040-160K	3